

**UPSIDE DOWN**

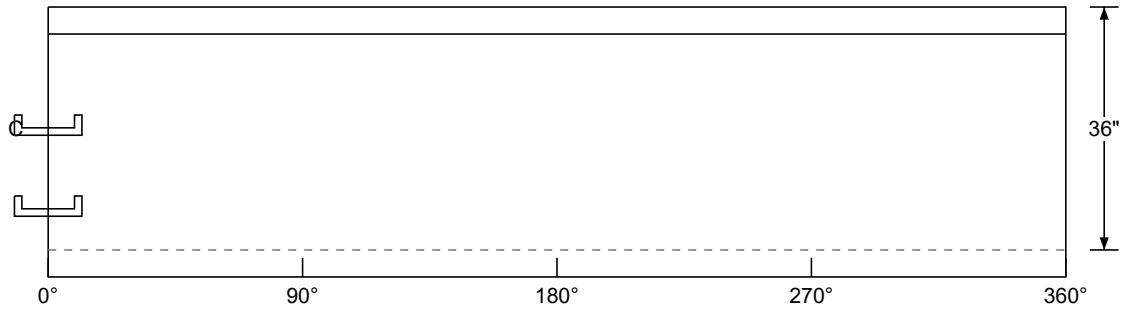

**UPSIDE DOWN**

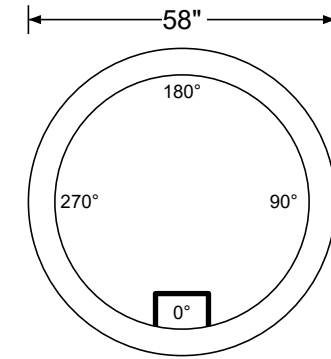

**NOTES:**

**RIGHT SIDE UP**

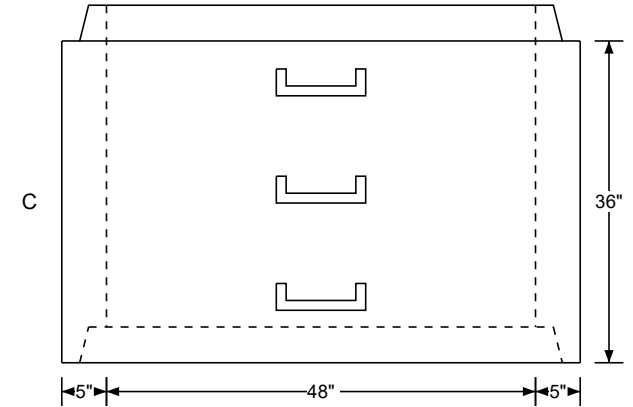

PipeNum	Elevation	Angle	Pipe	Connector	Opening Height	Opening Width	UptoBottom
---------	-----------	-------	------	-----------	----------------	---------------	------------



**Job Number:** STOCK  
**Job Name:** STOCK  
**Structure:** N/A  
**Description:** 48in SANITARY MANHOLE GREY  
**Sales Rep:** JCOPPAGE

**Part #:** MH048RS36  
**Desc:** Manhole 48in Riser, 36in Height Stock  
**Weight:** 2602 lbs.  
**Form:** 48 Riser 36in #5

**Dimension Tolerances**  
 Length, Width, Height, Wall Thickness:  $\pm 3/4"$   
 Rebar Spacing:  $\pm 1"$   
 Concrete Cover Over Reinforcing:  $> 1/2"$   
 Hole Size:  $\pm 1/2"$