

Job Name: 26-1980 833965 Carlock Dealership
 Job Location: Brentwood, TN
 Contractor: Contech Engineering Solutions

Plant: Beaver Dam
 4/15/2026 3:54:09 PM

Tech: S. Felletter
 PC: C. Goff



Structure ID: WQU2-2

P4 GR30x5x3

GRADE RING F/F

- P6) 30" - CASTING HEIGHT - 4"
- P5) 30" - GRADE RING F/F - 3"
- P4) 30" - GRADE RING F/F - 3"
- P3) 48" - MH FLAT LID w/30in ECC Hole F/G - 12"
- P2) 48" - MH RISER T/G - 24"
- P1) 48" - MH DH RISER T/F - 36"
- 1) CVSTENCILING
- 2) 48" - Conseal CS-102 1.00"

0 lb
 138 lb
 138 lb
 1413 lb
 1677 lb
 2515 lb
 0 lb
 0 lb

 Structure Total: 5882 lb

Structure Notes:
 4" CASTING BY OTHERS

- A. PER ASTM C478 SPECIFICATIONS.
- B. CONCRETE = 4,000 PSI AT 28 DAYS.
- C. NO STEPS

CONTECH'S LOGO MUST BE STENCILED ONTO THE STRUCTURE

REINFORCING PER ASTM A615 (GRADE 60).
 - TOP SLAB (As .62) #5 BARS AT 6" C.C.E.W.
 - RISER/WALLS (As .12)

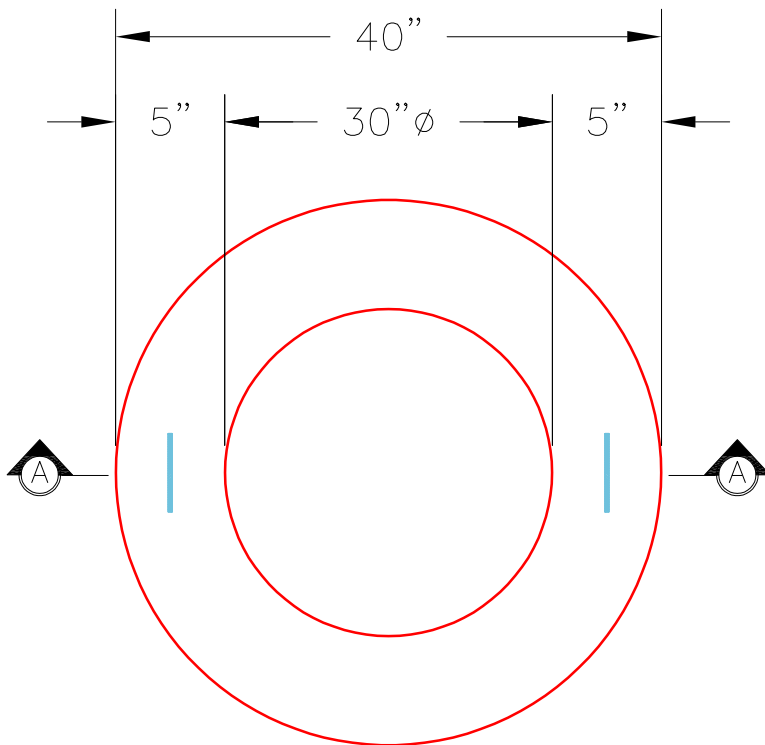

PLAN VIEW

NOTES:

1. GRADE RINGS MEET OR EXCEED THE FOLLOWING SPECIFICATIONS
 - CONCRETE: 4,000 PSI @ 28 DAYS
 - REINFORCING: (1) #3 HOOP CENTERED (GRADE 60)
2. WEIGHT: 3" 138 LBS.

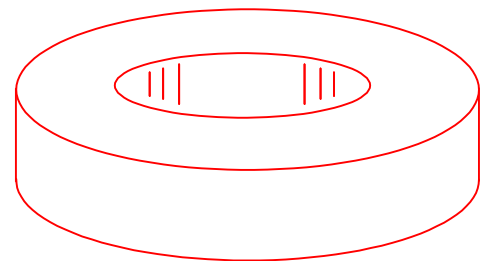

ISOMETRIC VIEW

2x CONAC WRA016 WIRE ROPE LIFTING ANCHORS

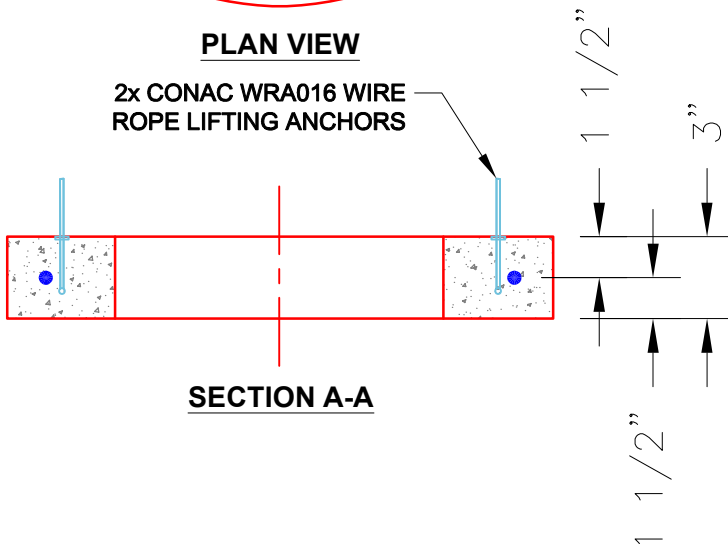

SECTION A-A

Coating (Int):
 Coating (Ext):

Seam Up: Flat
 Seam Dn: Flat

Wall Thickness: 5"

Height (Ext): 3"

Weight (Net): 138 lb
 Volume (Net): 0.04cu.yd