

Job Name: 26-1980 833965 Carlock Dealership  
 Job Location: Brentwood, TN  
 Contractor: Contech Engineering Solutions

Plant: Beaver Dam  
 4/15/2026 3:54:06 PM

Tech: S. Felletter  
 PC: C. Goff



**Structure ID: WQU1-2**

**P4 GR30x5x3**

**GRADE RING F/F**

- P6) 30" - CASTING HEIGHT - 4"
- P5) 30" - GRADE RING F/F - 3"
- P4) 30" - GRADE RING F/F - 3"
- P3) 48" - MH FLAT LID w/30in ECC Hole F/G - 12"
- P2) 48" - MH RISER T/G - 24"
- P1) 48" - MH DH RISER T/F - 36"
- 1) CVSTENCILING
- 2) 48" - Conseal CS-102 1.00"

0 lb  
 138 lb  
 138 lb  
 1413 lb  
 1677 lb  
 2515 lb  
 0 lb  
 0 lb  
 -----  
 Structure Total: 5882 lb

**Structure Notes:**  
 4" CASTING BY OTHERS

- A. PER ASTM C478 SPECIFICATIONS.
- B. CONCRETE = 4,000 PSI AT 28 DAYS.
- C. NO STEPS

CONTECH'S LOGO MUST BE STENCILED ONTO THE STRUCTURE

REINFORCING PER ASTM A615 (GRADE 60).  
 - TOP SLAB (As .62) #5 BARS AT 6" C.C.E.W.  
 - RISER/WALLS (As .12)

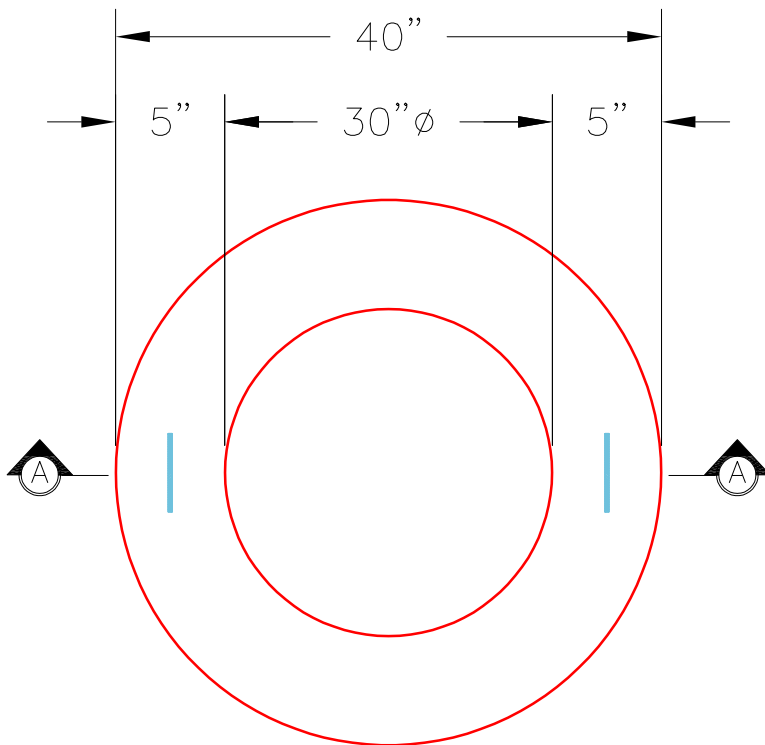

**PLAN VIEW**

**NOTES:**

1. GRADE RINGS MEET OR EXCEED THE FOLLOWING SPECIFICATIONS  
 - CONCRETE: 4,000 PSI @ 28 DAYS  
 - REINFORCING: (1) #3 HOOP CENTERED (GRADE 60)
2. WEIGHT: 3" 138 LBS.

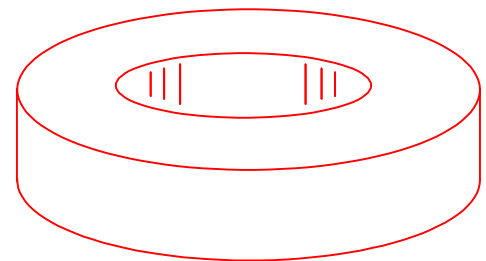

**ISOMETRIC VIEW**

2x CONAC WRA016 WIRE ROPE LIFTING ANCHORS

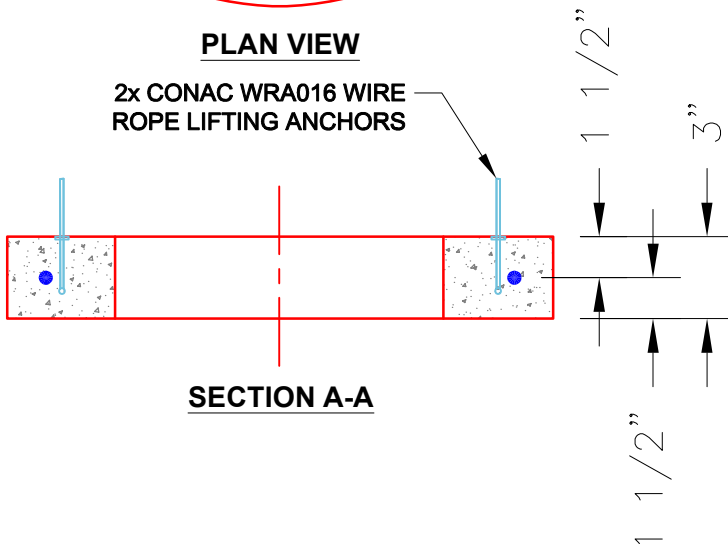

**SECTION A-A**

Coating (Int):  
 Coating (Ext):

Seam Up: Flat  
 Seam Dn: Flat

Wall Thickness: 5"

Height (Ext): 3"

Weight (Net): 138 lb  
 Volume (Net): 0.04cu.yd