

BELL ON OUTLET END AND SPICOT ON INLET END.

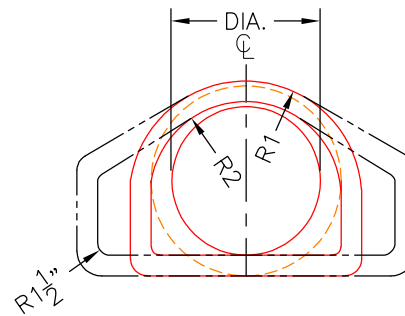

SECTION B-B

Job no. 26-1523
 Structure: FES 201-6 FES
 Part Ref.: P1
 Product Code: FES15B
 12" Flared End Section Bell (Outlet)

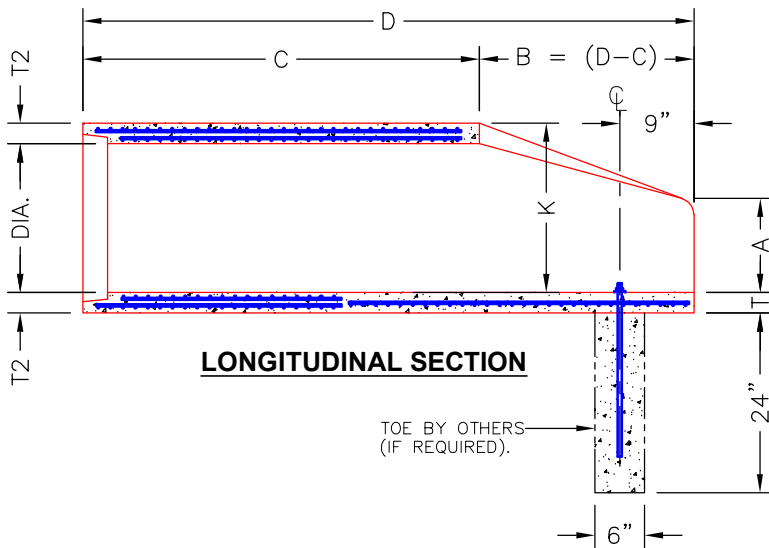
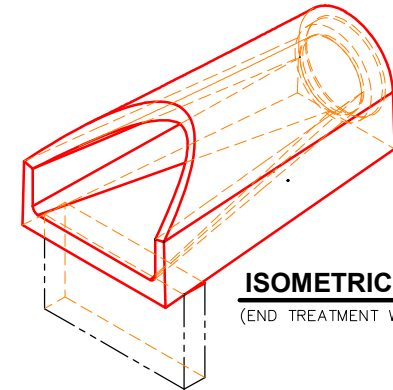

ISOMETRIC VIEW
 (END TREATMENT WITH BELL)

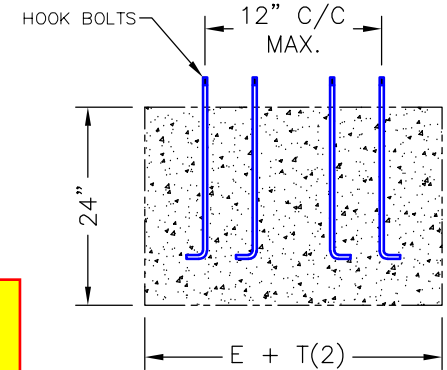

SECTION A-A
 CONCRETE PIPE TOE ANCHOR
 (POURED ON SITE BY OTHERS, IF REQUIRED)

TABLE OF DIMENSIONS

DIA.	T (MIN.)	T2 (MIN.)	A (±1")	B (±1")	C (±1")	D (±1")	E (±1")	K (FT.)	R1	R2	APPROX. WEIGHT (LBS.)
12"	2"	4"	6"	1'-11"	4'-3"	6'-2"	2'-0"	1.34'	10 3/8"	9"	1,400
15"	2 1/2"	4 7/8"	7 3/4"	2'-3"	4'-0"	6'-3"	2'-6"	1.63'	12 1/2"	11"	1,950
18"	2 1/2"	4 13/8"	9"	2'-1"	4'-1"	6'-2"	3'-0"	1.93'	15 1/2"	12"	2,510
24"	3"	5 13/8"	12"	3'-7"	2'-8"	6'-3"	4'-0"	2.48'	16 3/8"	14"	3,740
30"	3 1/2"	6 3/8"	15"	4'-5"	1'-10"	6'-3"	5'-0"	3.05'	18 1/2"	15"	4,930
36"	4"	7 3/8"	17"	5'-2"	3'-1"	8'-3"	6'-0"	3.75'	24 3/8"	20"	6,800

INFRASTRUCTURE PRECAST, INC.

981 WEST 7TH ST., BEAVER DAM, KY. 42320
 PHONE: (270) 363-2238, FAX: (270) 298-7424

INDOT PRECAST CONCRETE
 FLARED END SECTION

DRAWING NO.: ET-INDOT-300 DATE: 05-05-25
 REVIEWED BY: J.H. ROSS, PE DRAWN BY: N. RICHARDS
 WEB: WWW.ICASTINC.COM SCALE: NTS

