

Job Name: 26-1141 - KYTC Warren Co (261106)
Job Location: Bowling Green, KY
Contractor: Mick-Murf Construction Inc.

PC: C. Goff
 TECH: Jared - F
 Plant: 100



Structure ID: **A07 (26)**
 Spec: KYTC
 Type: CBI TYPE B (10')
 Size: 24" x 24"

Rim: 493.82'
 Invert: 489.5'
 Rim to Invert: 4.32'

Sump: 0"
 Floor (Top): 489.5'
 Floor Height: 8"

Floor (Bot): 488.833'
 Overall Height: 4.667'
 Slack: 3.84"

Structure Notes:

- ** KYTC STATE PROJECT **
- PER KYTC CBI TYPE B / ASTM C913 SPEC'S.
 - CONCRETE = 4,000 PSI AT 28 DAYS.
 - CASTING SUPPLIED BY OTHERS (HOE KY-345 SET (CBI B)).
- REINFORCING PER ASTM A615 (GRADE 60).
 - TOP PHASE (As .62) #5 BARS AT 6" C.C.E.W.
 - WALLS (As .31) #5 BARS AT 12" C.C.E.W.
 - FLOOR (As .31) #5 BARS AT 12" C.C.E.W.

STRUCTURE SUMMARY:

P3) 8" x 120" - CB INLET KY B 10' TOP - 9"	1660 lb
P2) 24" x 120" - CB INLET KY B 10' BOTTOM LEFT - 17"	2650 lb
P1) 24" x 24" - BOX BASE 8inW, 8inF, Variable Ht - 22"	2623 lb
1) 24" x 24" - Conseal CS-102 1.00"	0 lb
2) Hole - 18	0 lb
Structure Total:	6933 lb

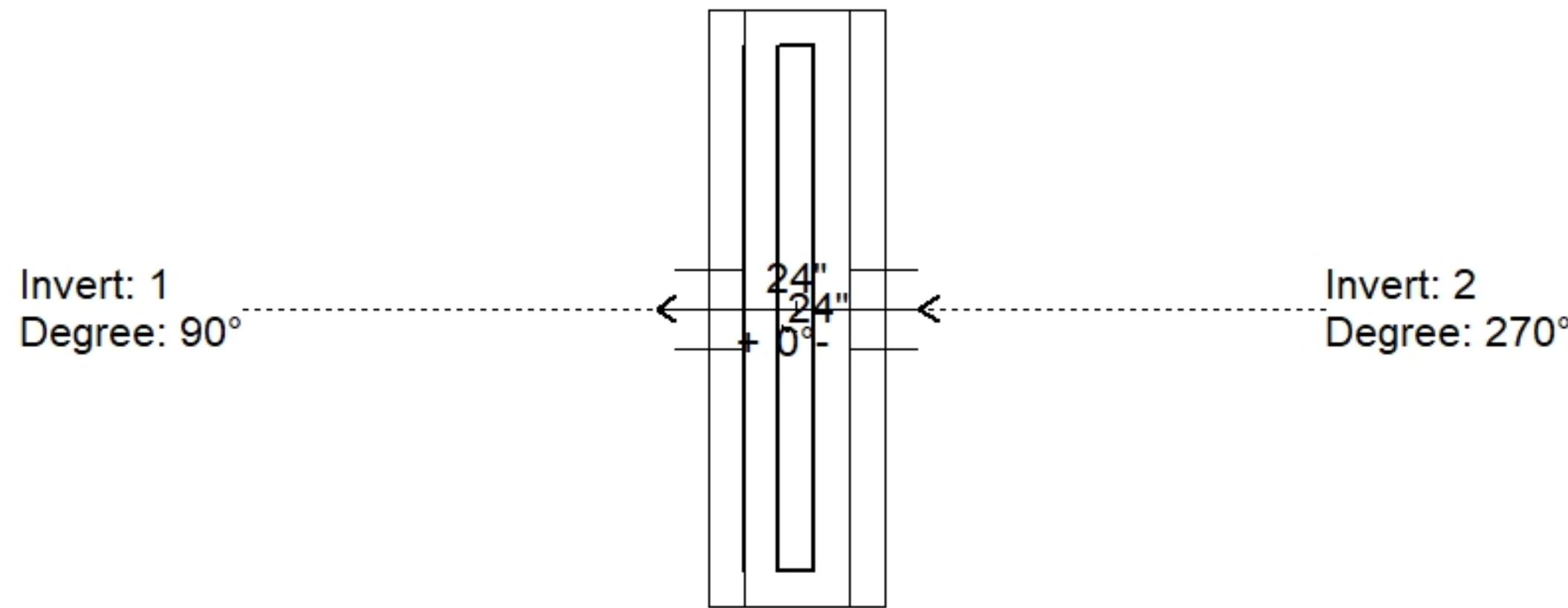

Position	Elev	Angle	Pipe	Pipe OD	Hole	Connector	Up (L)	Ref
Rim	493.82'							
Reducer								
Invert 1	489.5'	90°	15" CMP	16"	18"	Hole 18	-1.5"	P1
Invert 2	489.58'	270°	15" CMP	16"	18"	Hole 18	-0.54"	P1
Invert 3								
Invert 4								
Invert 5								
Invert 6								
Invert 7								
Invert 8								

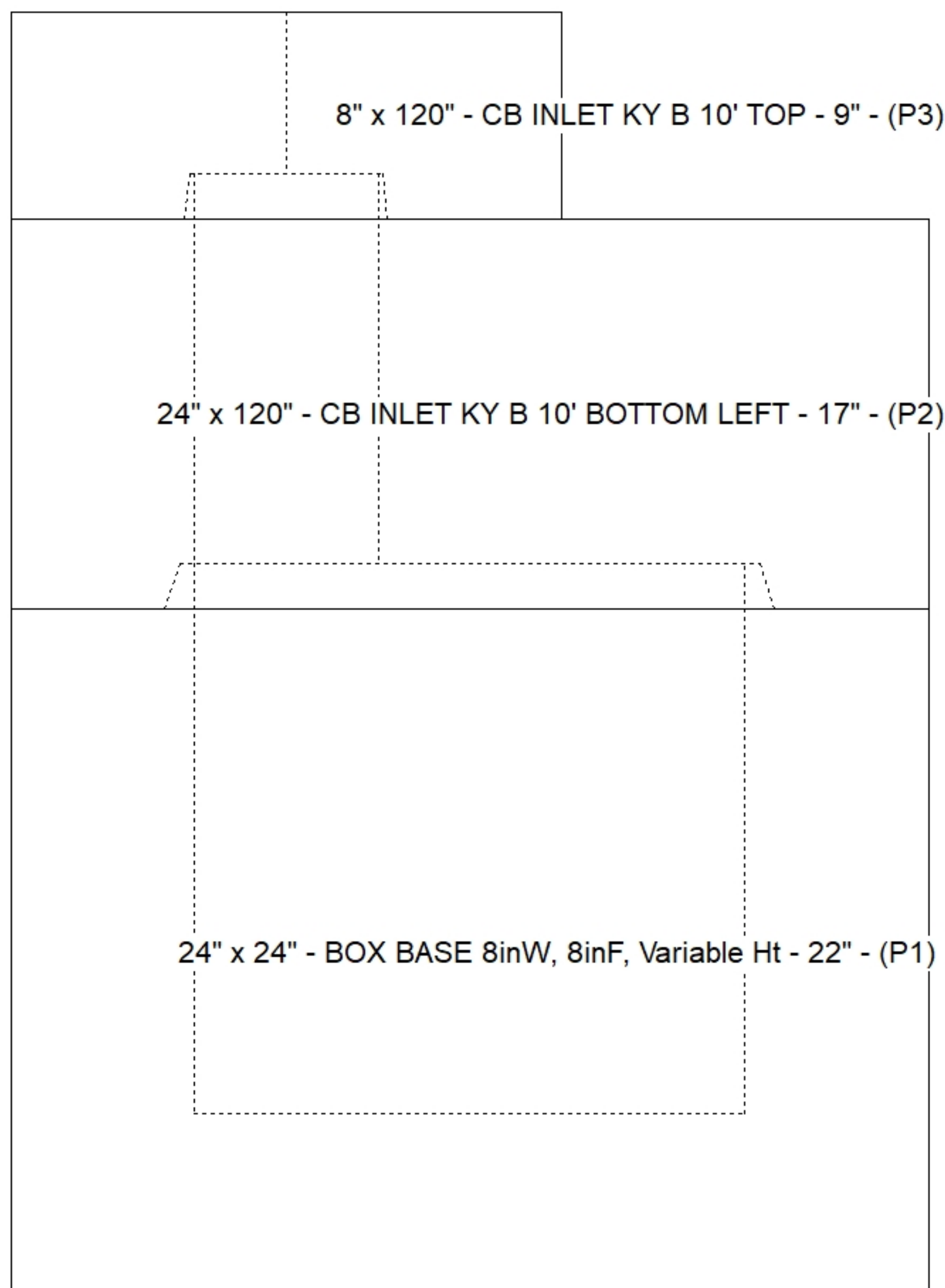

Default - Interior Dimensions

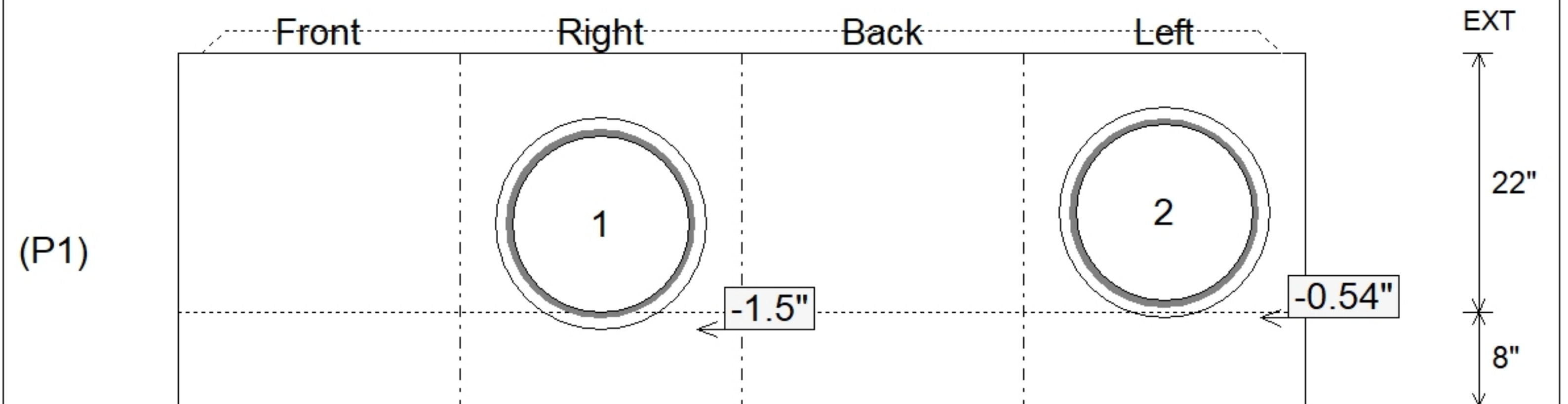

Submittal Drawing
 3/23/2026 1:18:31 PM

SUBMITTAL
 APPROVED BY: