

**Job Name: 25-4789 Garrison Gardens Utilities**  
**Job Location: Bowling Green, KY**  
**Contractor: Scott & Ritter, Inc.**

PC: C. Goff  
 TECH: S. Felletter  
 Plant: Beaver Dam



Structure ID: **san1-9 (10)**  
 Spec: Sanitary Rim: 519.92' Sump: 2" Floor (Bot): 515.193'  
 Type: SAN.MH Invert: 515.86' Floor (Top): 515.693' Overall Height: 4.583'  
 Size: 48" Rim to Invert: 4.06' Floor Height: 6" Slack: 1.72"

- Structure Notes:**
1. HOE MC-375 F/C SANITARY PROVIDED BY ICAST
  2. PER ASTM C478 SPECIFICATIONS.
  3. CONCRETE = 4,000 PSI AT 28 DAYS.
  4. REINFORCING PER ASTM A615 (GRADE 60).  
 - TOP SLAB (As .62) #5 BARS AT 6" C.C.E.W.  
 - RISER/WALLS (As .12)  
 - FLOOR (As .31) #5 BARS AT 12" C.C.E.W.
  5. DOUBLE PIPE BANDS REQUIRED FOR ALL BOOTS.

**STRUCTURE SUMMARY:**

P3) 24" - CASTING HEIGHT - 7"	0 lb
P2) 48" - MH FLAT TOP w/ 24" ECC Hole F/G - 12"	1561 lb
P1) 48" - MH BASE T/n - 30"	3309 lb
1) 48" - MH INVERT CHANNEL - FULL HEIGHT	1440 lb
1) Conseal CS-102 1.00" (Single)	0 lb
1) JOINT WRAP - 0.065"x6"x50' CONSEAL CS212	0 lb
1) JOINT WRAP PRIMER - CONSEAL CS-75 (1 gal.)	0 lb
1) CASTING - HOE MC-375 F/C Sanitary	271 lb
1) 48" - Conseal CS-102 1.00"	0 lb
2) PSX - 12-08 NYLO	16 lb
1) PSX - 8QRS-S NYLO	6 lb
2) MH Step ML-10-TDS-NCR - 10"	0 lb
<b>Structure Total:</b>	<b>6604 lb</b>

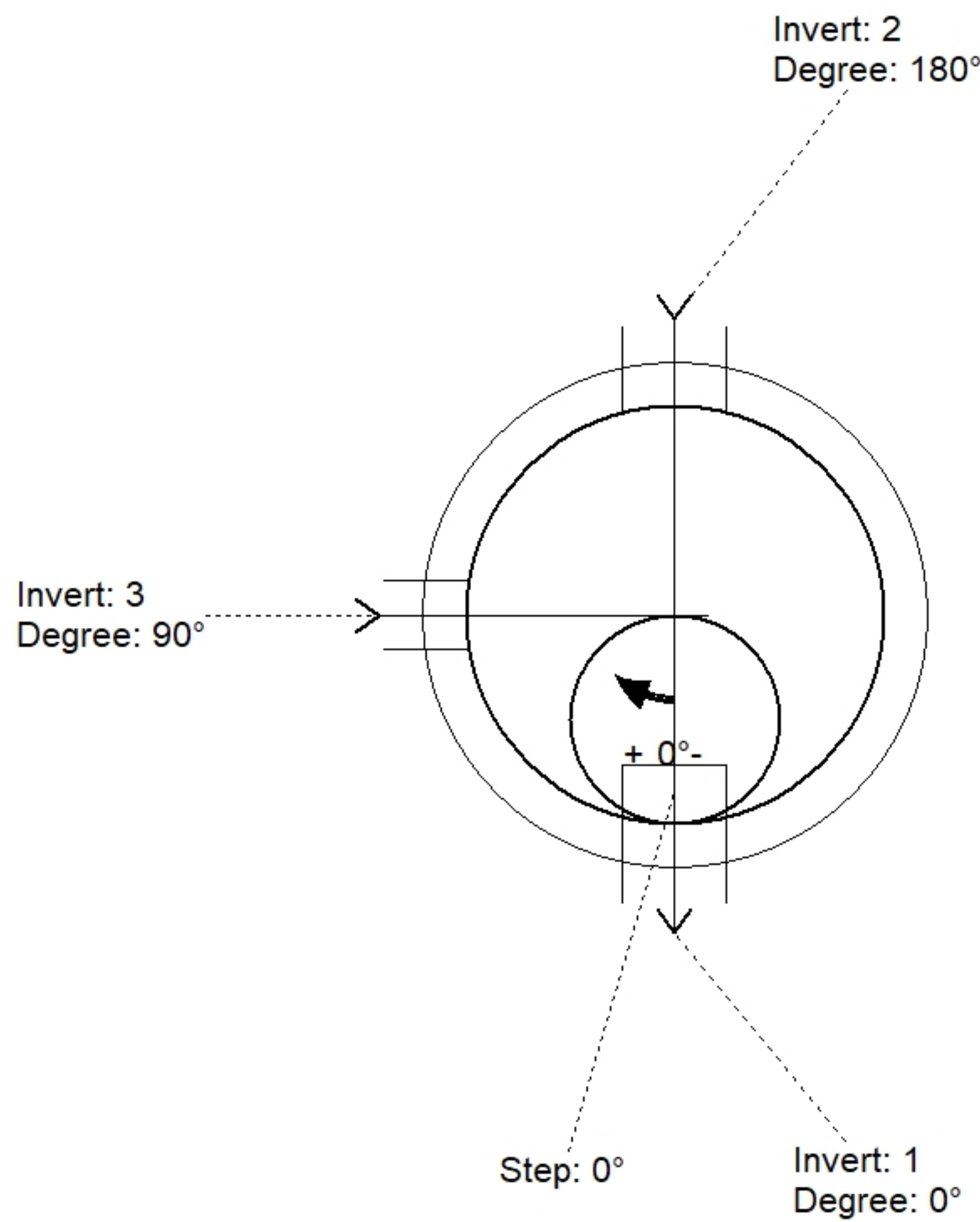

Position	Elev	Angle	Pipe	Pipe OD	Hole	Connector	Up (")	Ref
Rim	519.92'							
Reducer								
Invert 1	515.86'	0°	8" PVC SDR26	8.5"	12"	PSX 12-08 NYLO	0"	P1
Invert 2	515.96'	180°	8" PVC SDR26	8.5"	12"	PSX 12-08 NYLO	1.2"	P1
Invert 3	516.06'	90°	4" PVC SDR26	4.25"	8"	PSX 8QRS-S NYLO	2.4"	P1
Invert 4								
Invert 5								
Invert 6								
Invert 7								
Invert 8								

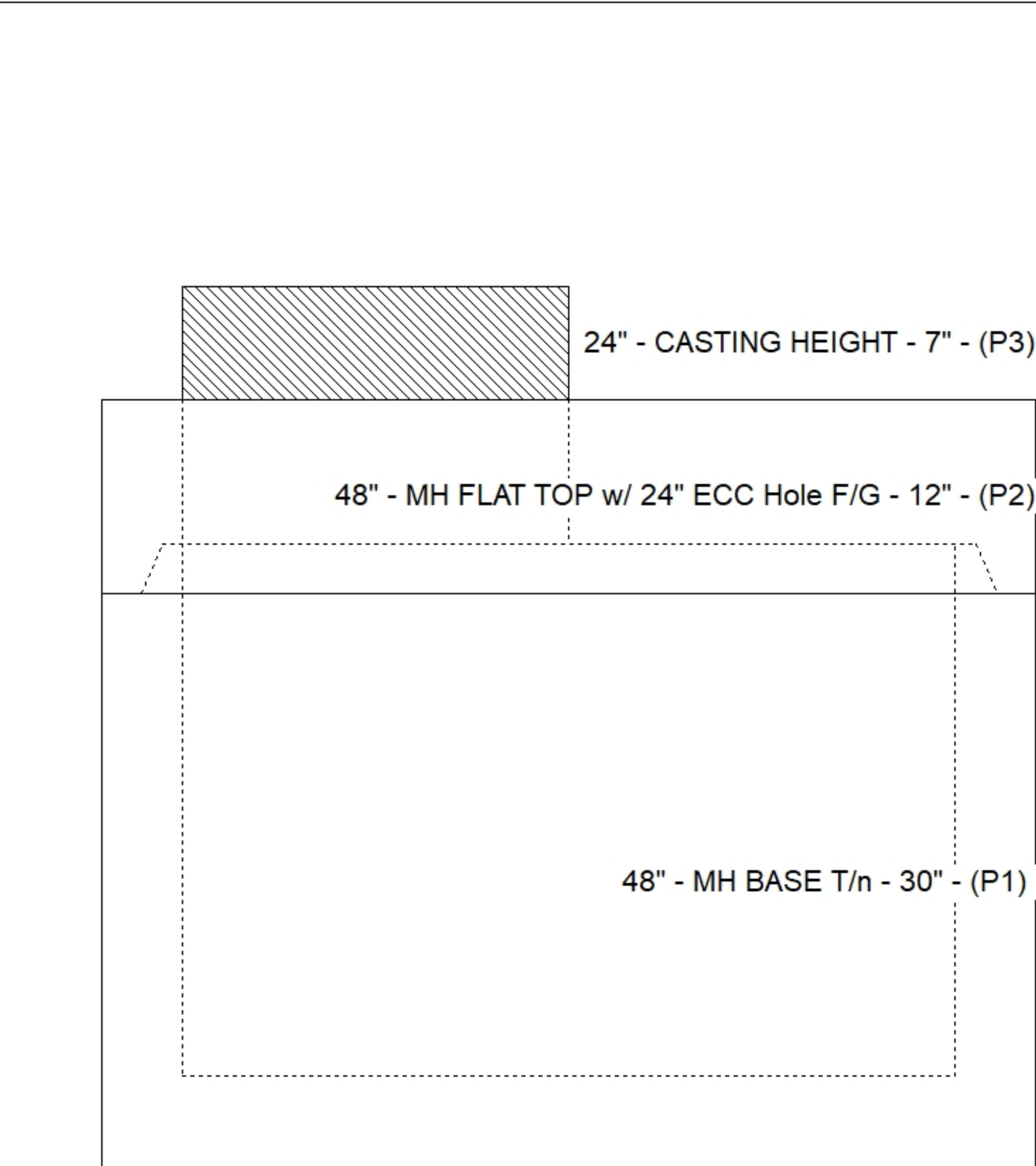

**Default - Interior Dimensions**

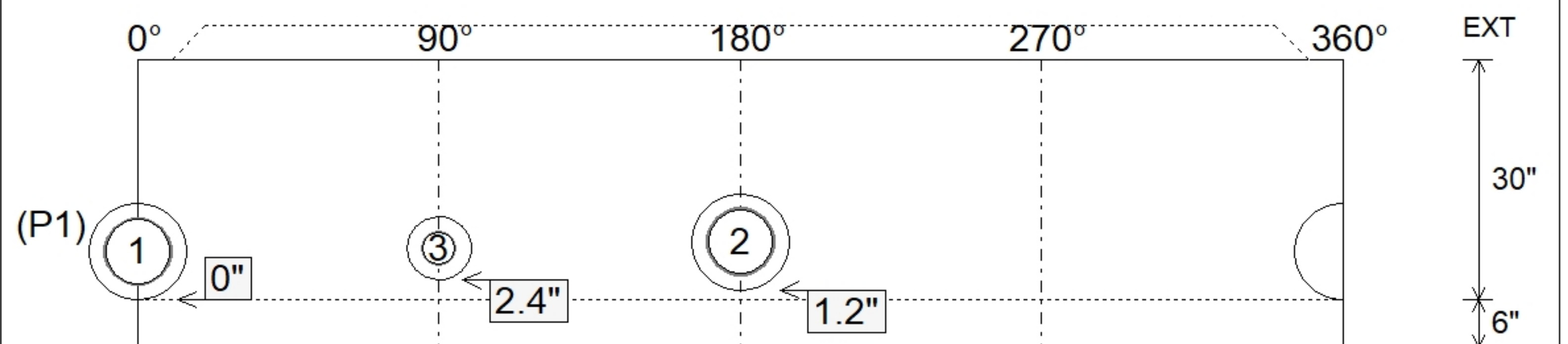

Submittal Drawing  
 4/20/2026 8:11:14 AM

SUBMITTAL  
 APPROVED BY: