

Job Name: 25-4789 Garrison Gardens Utilities
 Job Location: Bowling Green, KY
 Contractor: Scott & Ritter, Inc.

Plant: Beaver Dam

Tech: S. Felletter

4/16/2026 10:58:42 AM

PC: C. Goff



Structure ID: san1-6 (7)

P2 MH048LD12ECC

MH FLAT TOP w/ 24" ECC Hole F/G

- P3) 24" - CASTING HEIGHT - 7"
- P2) 48" - MH FLAT TOP w/ 24" ECC Hole F/G - 12"
- P1) 48" - MH BASE T/n - 36"
- 1) 48" - MH INVERT CHANNEL - FULL HEIGHT
- 1) Conseal CS-102 1.00" (Single)
- 1) JOINT WRAP - 0.065"x6"x50' CONSEAL CS212
- 1) JOINT WRAP PRIMER - CONSEAL CS-75 (1 gal.)
- 1) CASTING - HOE MC-375 F/C Sanitary
- 1) 48" - Conseal CS-102 1.00"
- 2) PSX - 12-08 NYLO
- 1) PSX - 8QRS-S NYLO
- 2) MH Step ML-10-TDS-NCR - 10"

- 0 lb
- 1561 lb
- 3728 lb
- 1440 lb
- 0 lb
- 0 lb
- 0 lb
- 0 lb
- 271 lb
- 0 lb
- 16 lb
- 6 lb
- 0 lb

Structure Notes:

1. HOE MC-375 F/C SANITARY PROVIDED BY ICAST
2. PER ASTM C478 SPECIFICATIONS.
3. CONCRETE = 4,000 PSI AT 28 DAYS.
4. REINFORCING PER ASTM A615 (GRADE 60).
 - TOP SLAB (As .62) #5 BARS AT 6" C.C.E.W.
 - RISER/WALLS (As .12)
- FLOOR (As .31) #5 BARS AT 12" C.C.E.W.
5. DOUBLE PIPE BANDS REQUIRED FOR ALL BOOTS.

Structure Total: 7023 lb

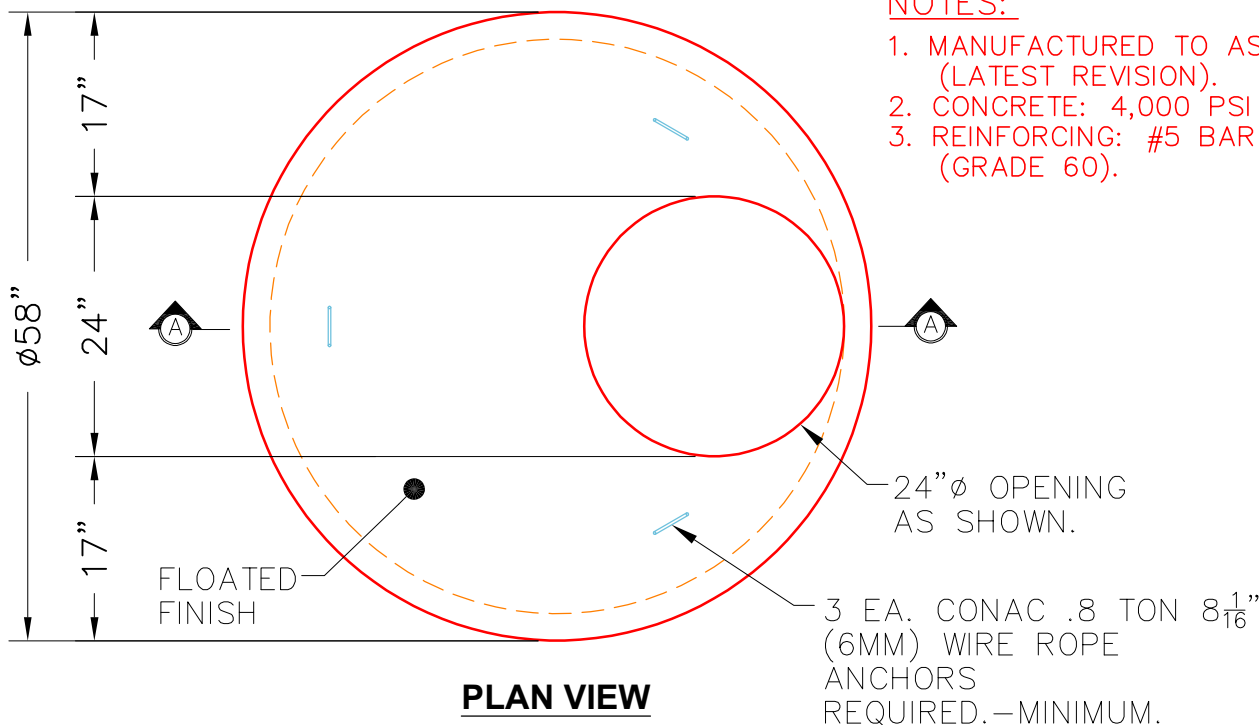

NOTES:

1. MANUFACTURED TO ASTM C-478 (LATEST REVISION).
2. CONCRETE: 4,000 PSI AT 28 DAYS.
3. REINFORCING: #5 BAR @ 6" C.C. E.W. (GRADE 60).

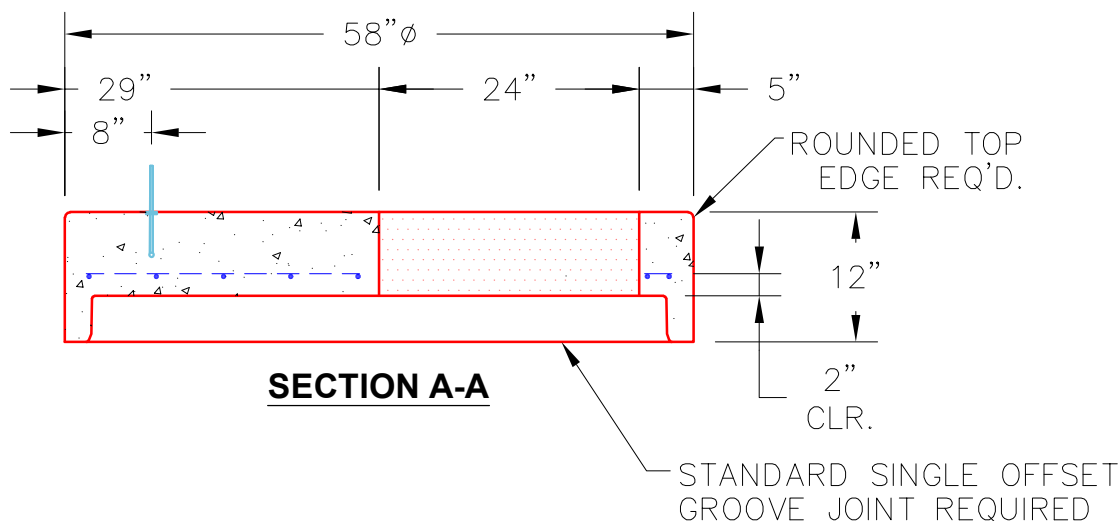

Coating (Int):
 Coating (Ext):

Seam Up: Flat
 Seam Dn: Groove

Wall Thickness: 5"

Height (Ext): 12"

Weight (Net): 1561 lb
 Volume (Net): 0.42cu.yd