

Job Name: 25-4503 TM Retail
 Job Location: Somerset, KY
 Contractor: Weddle Enterprises, Inc

Plant: 100

12/16/2025 2:13:15 PM

Tech: J. Horsley

PC: C. Goff



Structure ID: DI 3 (4)

P2 MH048LD12-18x36 RECT

MH FLAT TOP w/18"x36" Hole F/G

- P3) 18" x 36" - CASTING HEIGHT - 5.5"
- P2) 48" - MH FLAT TOP w/18"x36" Hole F/G - 12"
- P1) 48" - MH BASE Custom Ht T/n - 28"
- 1) 48" - SGL 1"x14.5' Butyl (2x)
- 2) Hole - 20
- 2) MH Step ML-10-TDS-NCR - 10"

0 lb
 2008 lb
 3016 lb
 0 lb
 0 lb
 0 lb
 0 lb

 Structure Total: 5024 lb

Structure Notes:
 1. PER ASTM C478 SPECIFICATIONS.
 2. CONCRETE = 4,000 PSI AT 28 DAYS.
 3. CASTING BY OTHERS (HOE 580 F/G).

 REINFORCING PER ASTM A615 (GRADE 60).
 - TOP SLAB = H20 LOADING.
 - RISER/WALLS (As .12)
 - FLOOR (As .31) #5 BARS AT 12" C.C.E.W.

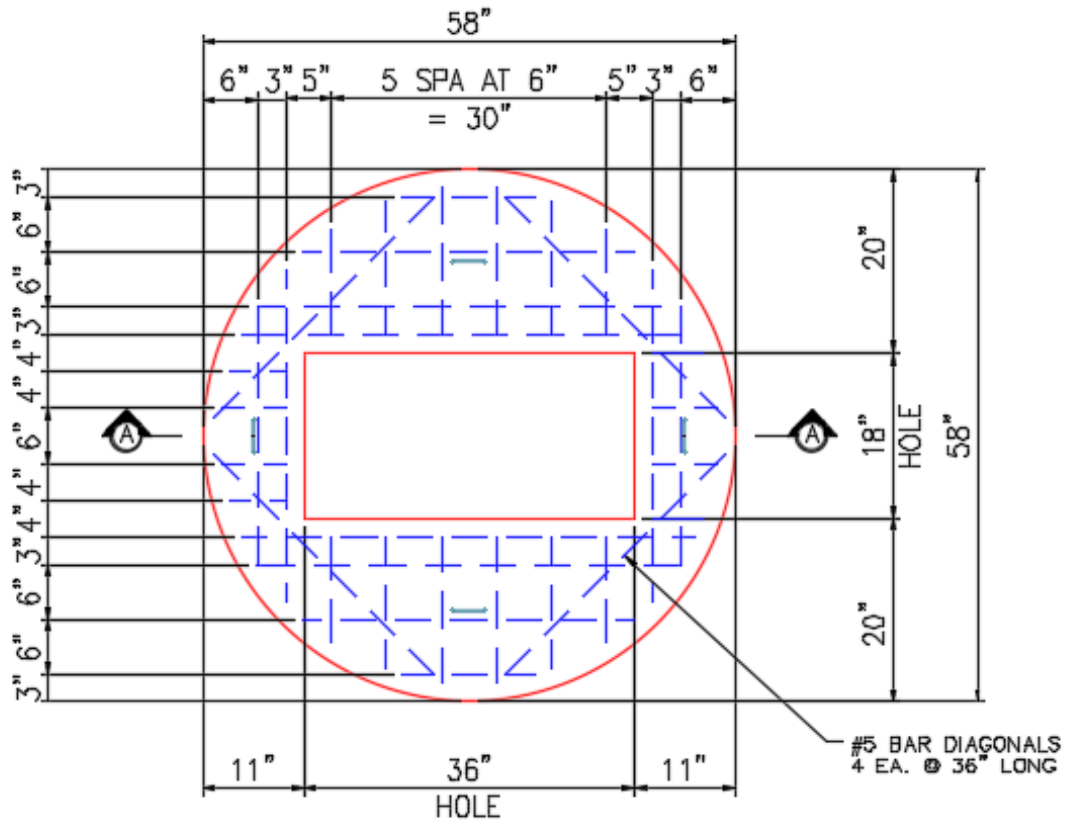

PLAN VIEW

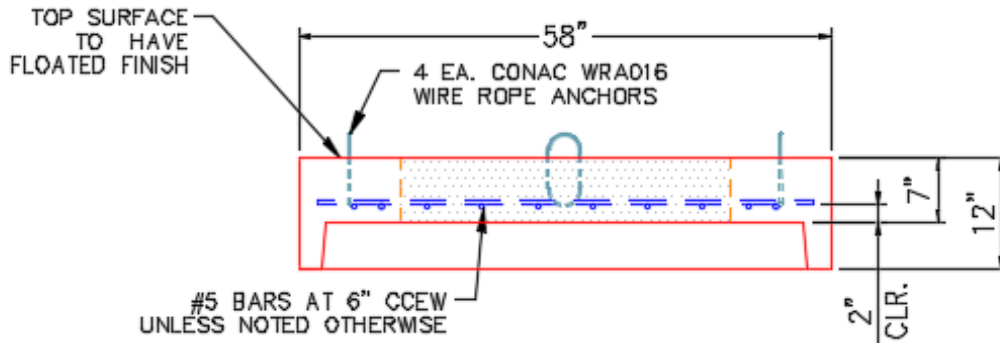

SECTION A-A

Coating (Int):
 Coating (Ext):

Seam Up: Flat
 Seam Dn: Groove

Wall Thickness: 5"

Height (Ext): 12"

Weight (Net): 2008 lb
 Volume (Net): 0.51cu.yd