

Job Name: 25-4502 - Smallhouse Rd Greenway  
 Job Location: Bowlgin Green, KY  
 Contractor: Apex Design Group, Inc.

Plant: 100  
 3/12/2026 7:32:56 AM

Tech: J. Horsley  
 PC: T. Lewis



**Structure ID: 802 (4)**

**P1 BX030030-08LD06-24C**

**CB FLAT TOP 6"W w/24"Hole F/F**

P1) 30" x 30" - CB FLAT TOP 6"W w/24"Hole F/F - 8"

Structure Total: 880 lb

Structure Notes:

1. PER ASTM C913 SPECIFICATIONS.
2. CONCRETE = 4,000 PSI AT 28 DAYS.
3. CASTING BY ICAST (HOE KY-206 TY. 1 F/C)

REINFORCING PER ASTM A615 (GRADE 60).  
 - TOP SLAB (As .62) #5 BARS AT 6" C.C.E.W.

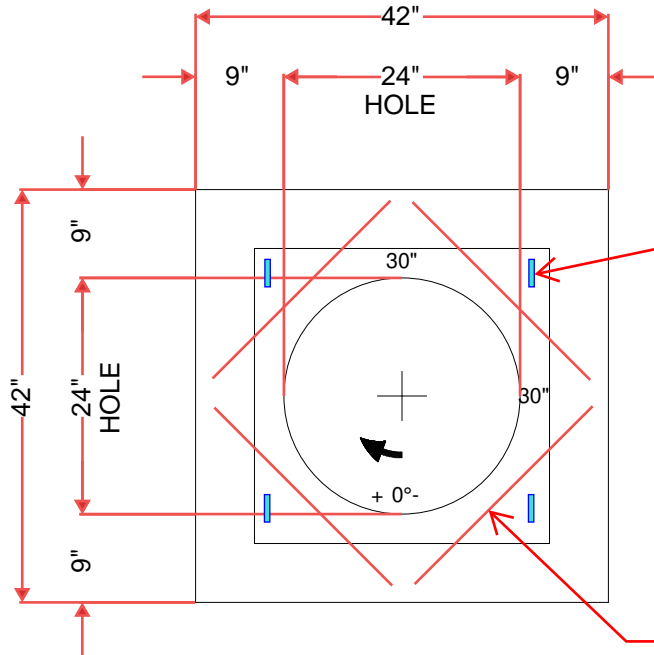

4ea. CONAC WRA016  
 WIRE LOOP LIFTERS  
 IN 8" FROM EACH SIDE

DIAGONAL BARS  
 4ea. #5 BARS x 26" LONG

SMOOTH FINISH  
 ON TOP SURFACE

#5 BARS  
 AT 6" C.C.E.W.

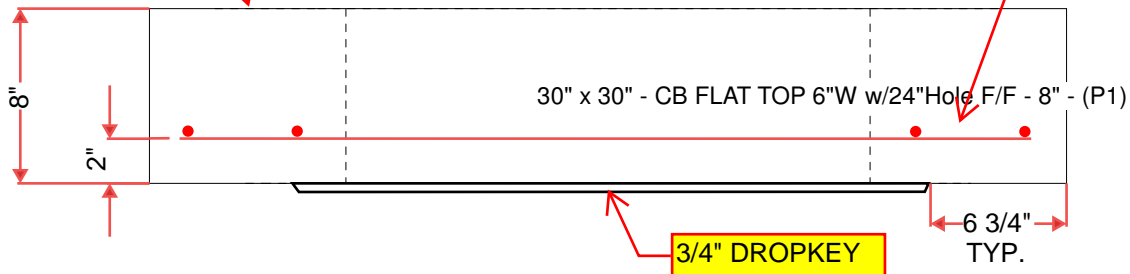

3/4" DROPKEY

Coating (Int):  
 Coating (Ext):

Seam Up: Flat  
 Seam Dn: Flat

Wall Thickness: 6"

Height (Ext): 8"

Weight (Net): 880 lb  
 Volume (Net): 0.22cu.yd