

Job Name: 25-4404 - Old Heritage Subdivision Section 7
 Job Location: Shelbyville, KY 40065
 Contractor: Filcon Construction

Plant: 100

Tech: J. Horsley - F

12/17/2025 2:02:27 PM

PC: C. Goff



Structure ID: 36

P3 MH048CN42

ECC CONE w/ 24" HOLE F/G

- P4) 24" - CASTING HEIGHT - 7"
- P3) 48" - ECC CONE w/ 24" HOLE F/G - 42"
- P2) 48" - MH RISER T/G - 48"
- P1) 48" - MH BASE T/n - 24"
- 1) JOINT WRAP - 0.065"x6"x50' CONSEAL CS212
- 1) JOINT WRAP PRIMER - CONSEAL CS-75 (1 gal.)
- 1) 48" - MH INVERT CHANNEL - FULL HEIGHT
- 2) 48" - Conseal CS-102 1.00" (Double)
- 2) PSX - 12-08 NYLO
- 9) MH Step ML-10-TDS-NCR - 10"

0 lb
3200 lb
3353 lb
2911 lb
0 lb
0 lb
1440 lb
0 lb
16 lb
0 lb

Structure Total: 10920 lb

- Structure Notes:
1. PER ASTM C-478 SPECIFICATIONS
 2. CONCRETE: 4,000 PSI AT 28 DAYS
 3. REINFORCEMENT: PER ASTM A615
 4. INVERT CHANNEL REQUIRED
 5. STEPS AT 0 DEGREES
 6. CASTING SUPPLIED BY OTHERS

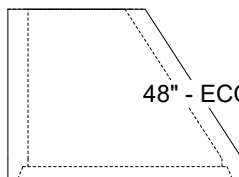
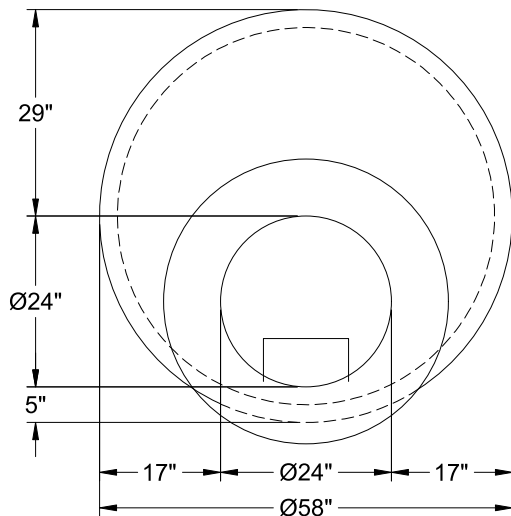

48" - ECC CONE w/ 24" HOLE F/G - 42" - (P3)

Coating (Int):
 Coating (Ext):

Seam Up: Flat
 Seam Dn: Groove

Wall Thickness: 5"

Height (Ext): 42"

Weight (Net): 3200 lb
 Volume (Net): 0.5cu.yd