

Job Name: 25-4337 - Maywood Phase13
 Job Location: Bardstown, KY
 Contractor: Buzick Construction

Plant: 100

12/9/2025 11:29:24 AM

Tech: J. Horsley - F

PC: C. Goff



Structure ID: A6

P4 GR3

GRADE RING F/F

- P5) 24" - CASTING HEIGHT - 7"
- P4) 24" - GRADE RING F/F - 3"
- P3) 48" - ECC CONE w/ 24" HOLE F/G - 24"
- P2) 48" - MH RISER T/G - 60"
- P1) 48" - MH BASE T/n - 30"
- 1) JOINT WRAP - 0.065"x6"x50' CONSEAL CS212
- 1) JOINT WRAP PRIMER - CONSEAL CS-75 (1 gal.)
- 1) 48" - MH INVERT CHANNEL - FULL HEIGHT
- 2) 48" - Conseal CS-102 1.00" (Double)
- 3) PSX - 12-08 NYLO
- 9) MH Step ML-10-TDS-NCR - 10"

0 lb
 202 lb
 1550 lb
 4192 lb
 3282 lb
 0 lb
 0 lb
 1440 lb
 0 lb
 24 lb
 0 lb

 Structure Total: 10690 lb

Structure Notes:

1. PER ASTM C-478 SPECIFICATIONS
2. CONCRETE: 4,000 PSI AT 28 DAYS
3. REINFORCEMENT: (1) #3 HOOP CENTERED (GRADE 60)

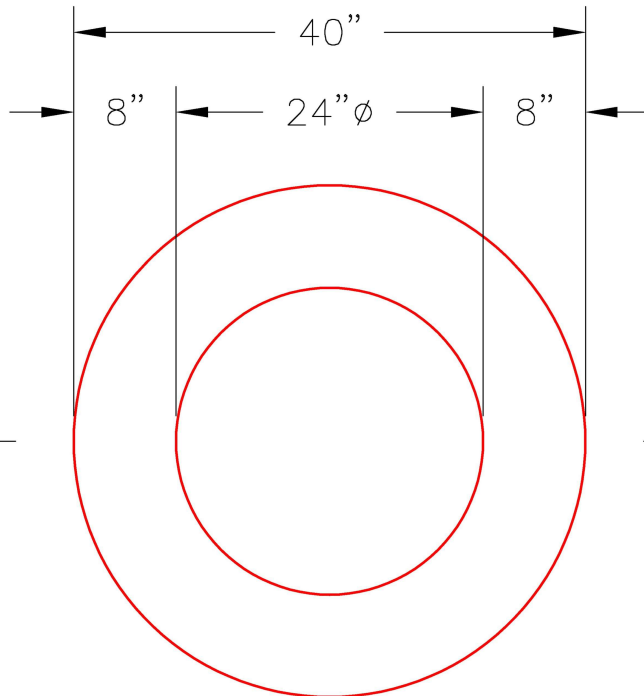

PLAN VIEW

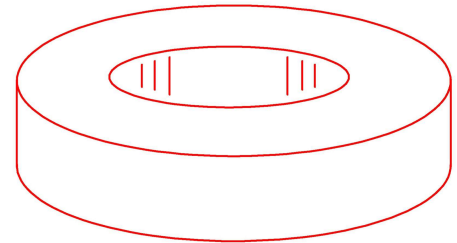

ISOMETRIC VIEW

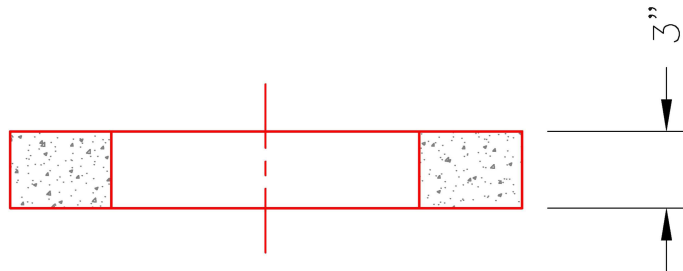

SECTION A-A

Coating (Int):
 Coating (Ext):

Seam Up: Flat
 Seam Dn: Flat

Wall Thickness: 8"

Height (Ext): 3"

Weight (Net): 202 lb
 Volume (Net): 0.05cu.yd