

Job Name: 25-4337 - Maywood Phase13
 Job Location: Bardstown, KY
 Contractor: Buzick Construction

Plant: 100
 12/5/2025 1:00:54 PM

Tech: J. Horsley - F
 PC: C. Goff



Structure ID: A3

P3 GR4

GRADE RING F/F

- P4) 24" - CASTING HEIGHT - 7"
- P3) 24" - GRADE RING F/F - 4"
- P2) 48" - ECC CONE w/ 24" HOLE F/G - 36"
- P1) 48" - MH BASE T/n - 30"
- 1) JOINT WRAP - 0.065"x6"x50' CONSEAL CS212
- 1) JOINT WRAP PRIMER - CONSEAL CS-75 (1 gal.)
- 1) 48" - MH INVERT CHANNEL - FULL HEIGHT
- 1) 48" - Conseal CS-102 1.00" (Double)
- 2) PSX - 12-08 NYLO
- 5) MH Step ML-10-TDS-NCR - 10"

0 lb
 270 lb
 3000 lb
 3330 lb
 0 lb
 0 lb
 1440 lb
 0 lb
 16 lb
 0 lb

 Structure Total: 8056 lb

Structure Notes:
 1. PER ASTM C-478 SPECIFICATIONS
 2. CONCRETE: 4,000 PSI AT 28 DAYS
 3. REINFORCEMENT: (1) #3 HOOP CENTERED (GRADE 60)

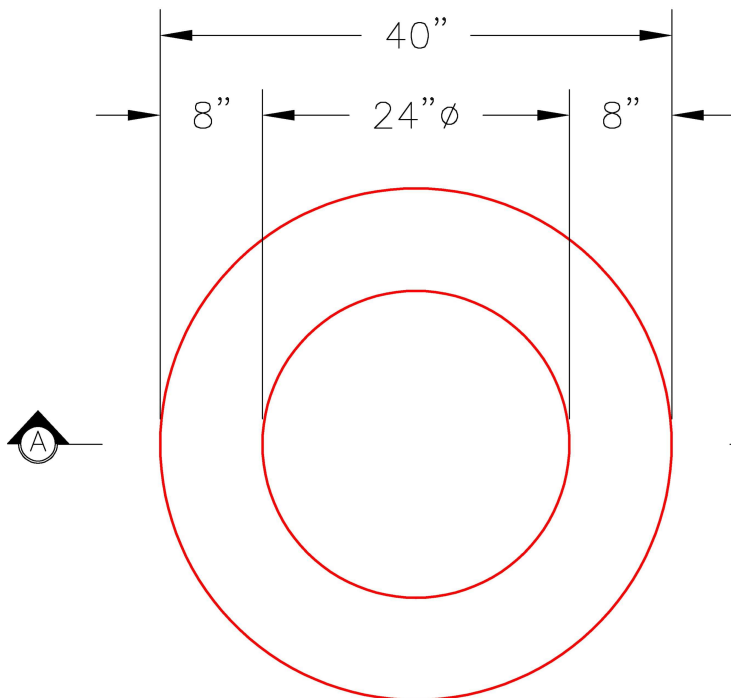

PLAN VIEW

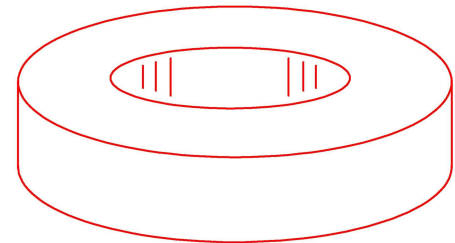

ISOMETRIC VIEW

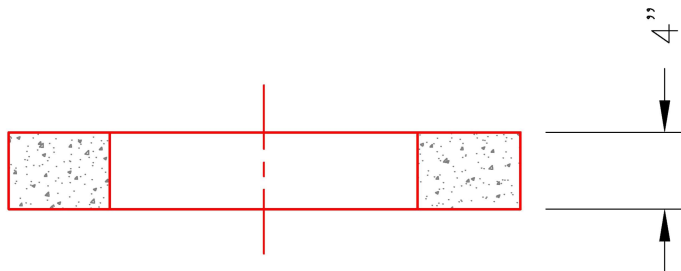

SECTION A-A

Coating (Int):
 Coating (Ext):

Seam Up: Flat
 Seam Dn: Flat

Wall Thickness: 8"

Height (Ext): 4"

Weight (Net): 270 lb
 Volume (Net): 0.07cu.yd