

Job Name: 25-4299 - Seneca High School
 Job Location: Louisville, KY
 Contractor: Dan Cristiani Excavating Co. Inc.

Plant: 100
 2/10/2026 8:29:00 AM

Tech: J. Horsley
 PC: J. Jarvis



Structure ID: 0+91.68

P2 MH048CN42

ECC CONE w/ 24" HOLE F/G

- P3) 24" - CASTING HEIGHT - 7"
- P2) 48" - ECC CONE w/ 24" HOLE F/G - 42"
- P1) 48" - MH BASE T/n - 36"
- 1) 48" - MH INVERT CHANNEL - FULL HEIGHT
- 1) JOINT WRAP - 0.065"x6"x50" CONSEAL CS212
- 1) JOINT WRAP PRIMER - CONSEAL CS-75 (1 gal.)
- 1) Chimney Seal - Cretex Chimney Seal
- 1) 48" - Conseal CS-102 1.00" (Double)
- 2) PSX - 12-08 NYLO
- 6) MH Step ML-10-TDS-NCR - 10"

0 lb
 3200 lb
 3749 lb
 1440 lb
 0 lb
 0 lb
 10 lb
 0 lb
 16 lb
 0 lb

 Structure Total: 8415 lb

- Structure Notes:
1. PER LOUISVILLE MSD / ASTM C-478 SPECIFICATIONS
 2. CONCRETE: 4,000 PSI AT 28 DAYS
 3. REINFORCEMENT: PER ASTM A615
 4. CRETEX CHIMNEY SEAL SUPPLIED BY ICAST
 5. STEPS REQUIRED
 6. HOE MC-420 FRAME & COVER "SANITARY LOU-MSD" SUPPLIED BY OTHERS

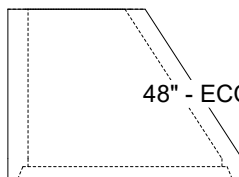
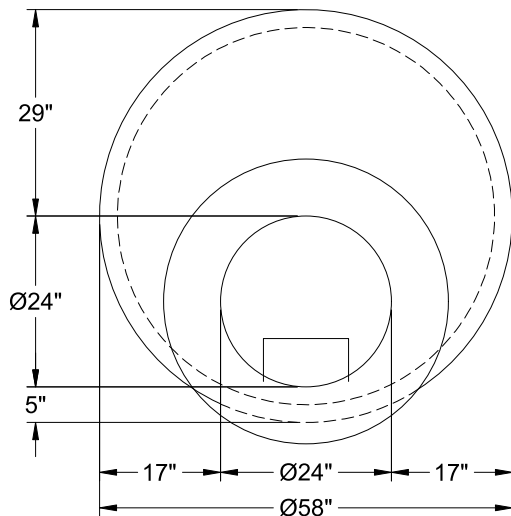

48" - ECC CONE w/ 24" HOLE F/G - 42" - (P2)

Coating (Int):
 Coating (Ext):

Seam Up: Flat
 Seam Dn: Groove

Wall Thickness: 5"

Height (Ext): 42"

Weight (Net): 3200 lb
 Volume (Net): 0.5cu.yd