

Job Name: 25-4284 - Bean Cemetery Rd Water Line Extension  
 Job Location: Madisonville, KY  
 Contractor: Luttrell & Sons, LLC

Plant: 100  
 4/24/2026 5:50:32 PM

Tech: Jared - F  
 PC: A. Chambers



**Structure ID: ARV-2**

**P2 MH048DHVF**

**MH DH RISER Custom Ht T/F**

- P4) 24" - CASTING HEIGHT - 7"
- P3) 48" - MH FLAT TOP w/ 24" ECC Hole F/G - 12"
- P2) 48" - MH DH RISER Custom Ht T/F - 57"
- P1) 48" - P.I.P. BY OTHERS - BTM SLAB F/n - 0"
- 1) CASTING - HOE MC-375-SS F/Vented Cover
- 2) 48" - Conseal CS-102 1.00" (Double)
- 2) DOGHOUSE - 14"x20"

0 lb  
 1561 lb  
 3724 lb  
 0 lb  
 271 lb  
 0 lb  
 0 lb  
 -----  
 Structure Total: 5556 lb

**Structure Notes:**  
 1. PER ASTM C478 SPECIFICATIONS.  
 2. CONCRETE = 4,000 PSI AT 28 DAYS.  
 3. NO STEPS AND NO INVERT CHANNEL.  
 4. CASTING BY ICAST (HOE MC-375 F/VENTED COVER).  
 5. FOOTERS BY OTHERS

REINFORCING PER ASTM A615 (GRADE 60).  
 - TOP SLAB (As .62) #5 BARS AT 6" C.C.E.W.  
 - RISER/WALLS (As .12)

Rim: 5.83' Rim to Invert: 5.83' Slack: -0.04" Sump: 6" Step Position:

Position	Elev	Angle	Ext. (cw)	Pipe	Pipe OD	Connector	Hole	Horz Size	Up (↓)	Offset
Invert 1	0'	0°	-12.375"	10" PVC SDR35	10.5"	DOGHOUSE 14"x20"	14" x 20"	16.888"	1"	-12"
Invert 2	0'	180°	103.5"	10" PVC SDR35	10.5"	DOGHOUSE 14"x20"	14" x 20"	16.888"	1"	12"
Invert 3										
Invert 4										
Invert 5										
Invert 6										
Invert 7										
Invert 8										

**RIGHT-SIDE UP VIEW (int. dimensions)**

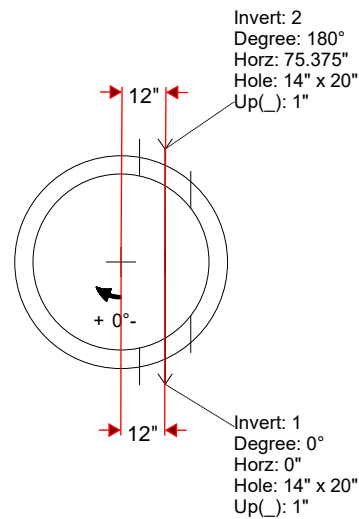
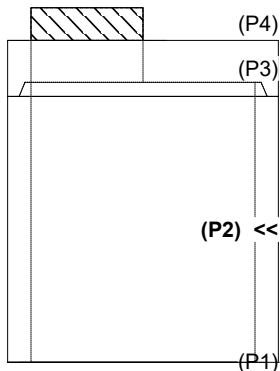

**INSIDE WALL DIMENSIONS**

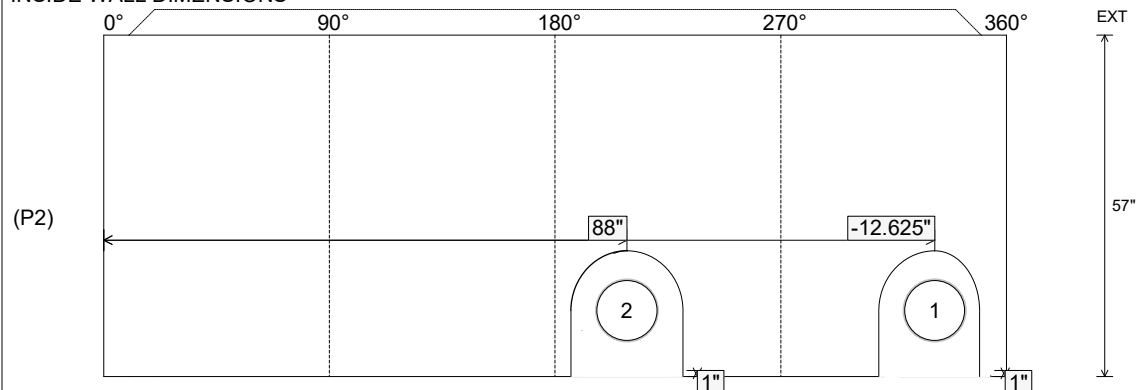

Coating (Int): Coating (Ext):	Seam Up: Tongue Seam Dn: Flat	Wall Thickness: 5" Floor Height: 0"	Height (Int): 57" Height (Ext): 57"	Weight (Net): 3724 lb Volume (Net): 0.95cu.yd
----------------------------------	----------------------------------	--	--	--