

Job Name: 25-4245 - KYTC Marion Co Call 104 (251015)
Job Location: Lebanon, KY
Contractor: Rame Contracting LLC

PC: Celina Goff
 TECH: J. Horsley - A
 Plant: 100



Structure ID: 18
 Spec: KYTC
 Type: CBI TYPE A (10')
 Size: 24" x 36"

Rim: 845.19'
 Invert: 840.11'
 Rim to Invert: 5.08'

Sump: 0"
 Floor (Top): 840.11'
 Floor Height: 8"

Floor (Bot): 839.443'
 Overall Height: 5.583'
 Slack: 1.96"

Structure Notes:

- ** KYTC STATE PROJECT **
- 1. HOE KY-206 FRAME & COVER (KY TY 1) PROVIDED BY ICAST
- FRAME TO BE CAST INTO TOP PHASE TOP FLANGE SIDE UP
- 2. PER KYTC CBI TYPE A / ASTM C-913 SPECS
- 3. CONCRETE: 4,000 PSI AT 28 DAYS
- 4. REINFORCEMENT:
- TOP PHASE TOP: #5 BAR @ 6" C.C. E.W. (GRADE 60)
- TOP PHASE BOTTOM: #5 BAR @ 12" C.C. E.W. (GRADE 60)
- PIPE CHAMBER: #5 BAR @ 12" C.C. E.W. (GRADE 60)
- 5. NO INVERT CHANNEL

STRUCTURE SUMMARY:

P3) 24" x 120" - CB INLET KY A 10' TOP LEFT F/G - 10"	3400 lb
P2) 24" x 120" - CB INLET KY A 10' BOTTOM LEFT T/G - 18"	5270 lb
P1) 24" x 36" - BOX BASE 8inW, 8inF, Variable Ht T/n - 31"	4011 lb
1) CASTING - HOE KY-206 F/C (KY TY1)	206 lb
1) 24" x 36" - Conseal CS-102 1.00"	0 lb
2) Hole - 22"	0 lb
2) Hole - 6"	0 lb
Structure Total:	12887 lb

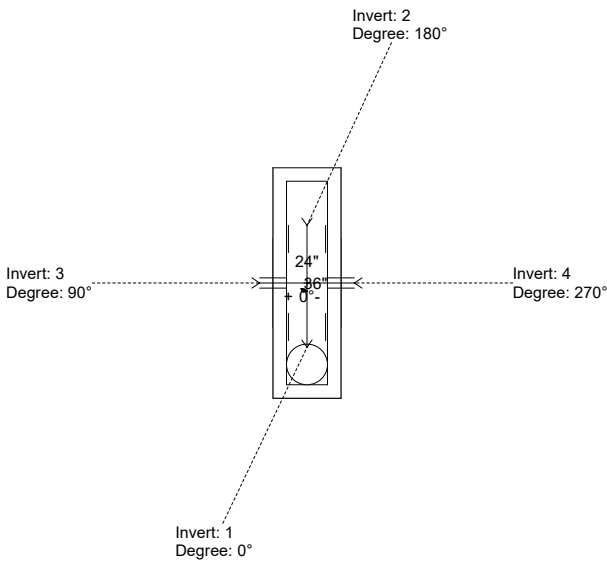

Position	Elev	Angle	Pipe	Pipe OD	Hole	Connector	Up (L)	Ref
Rim	845.19'							
Reducer								
Invert 1	840.11'	0°	18" CMP	19"	22"	Hole 22	-2"	P1
Invert 2	840.11'	180°	18" CMP	19"	22"	Hole 22	-2"	P1
Invert 3	840.61'	90°	4" HDPE (perf pipe)	4.8"	6"	Hole 6	5"	P1
Invert 4	840.61'	270°	4" HDPE (perf pipe)	4.8"	6"	Hole 6	5"	P1
Invert 5								
Invert 6								
Invert 7								
Invert 8								

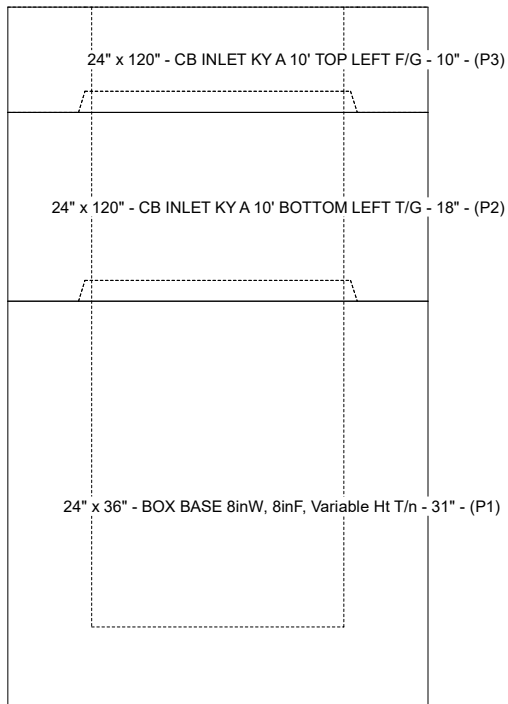

Cast (Int. Dim.) - Interior Dimensions

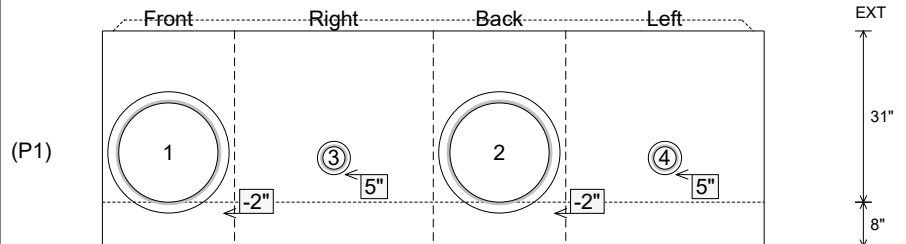

Submittal Drawing
 12/29/2025 11:42:48 AM

SUBMITTAL
 APPROVED BY: