

**Job Name: 25-3505 KYTC Multi Co Call 200 (251117)**

**Job Location:**

**Contractor: Jim Smith Contracting Co, LLC**

PC: Jay Ross Jarvis

TECH: J. Coppage - A

Plant: 100



Structure ID: 1402 84

Spec: KYTC

Type: DBI TYPE 5

Size: 36" x 48"

Rim: 479.35'

Invert: 476.6'

Rim to Invert: 2.75'

Sump: 0"

Floor (Top): 476.6'

Floor Height: 8"

Floor (Bot): 475.933'

Overall Height: 3.417'

Slack: 0"

Structure Notes:

\*\*KYTC STATE PROJECT\*\*

1. HOE KY-460 SET (DBI 5D) PROVIDED BY ICAST.
2. KYTC DBI TYPE 5
3. PER ASTM C-913
  - WALLS (As .31) #5 BARS AT 12" C.C.E.W..
  - FLOOR (As .31) #5 BARS AT 12" C.C.E.W.
4. STUB #5 BARS 20" OUT TOP OF WALLS (SPA@12"C/C)

STRUCTURE SUMMARY:

P2) 36" x 48" - P.I.P. - BY OTHERS - 8"	0 lb
P1) 36" x 48" - BOX BASE 8inW, 8inF, Variable Ht - 25"	5287 lb
1) CASTING - HOE KY-460 SET (DBI 5D)	460 lb
1) 36" x 48" - Conseal CS-102 1.00"	0 lb
1) Hole - 24	0 lb
	-----
Structure Total:	5747 lb

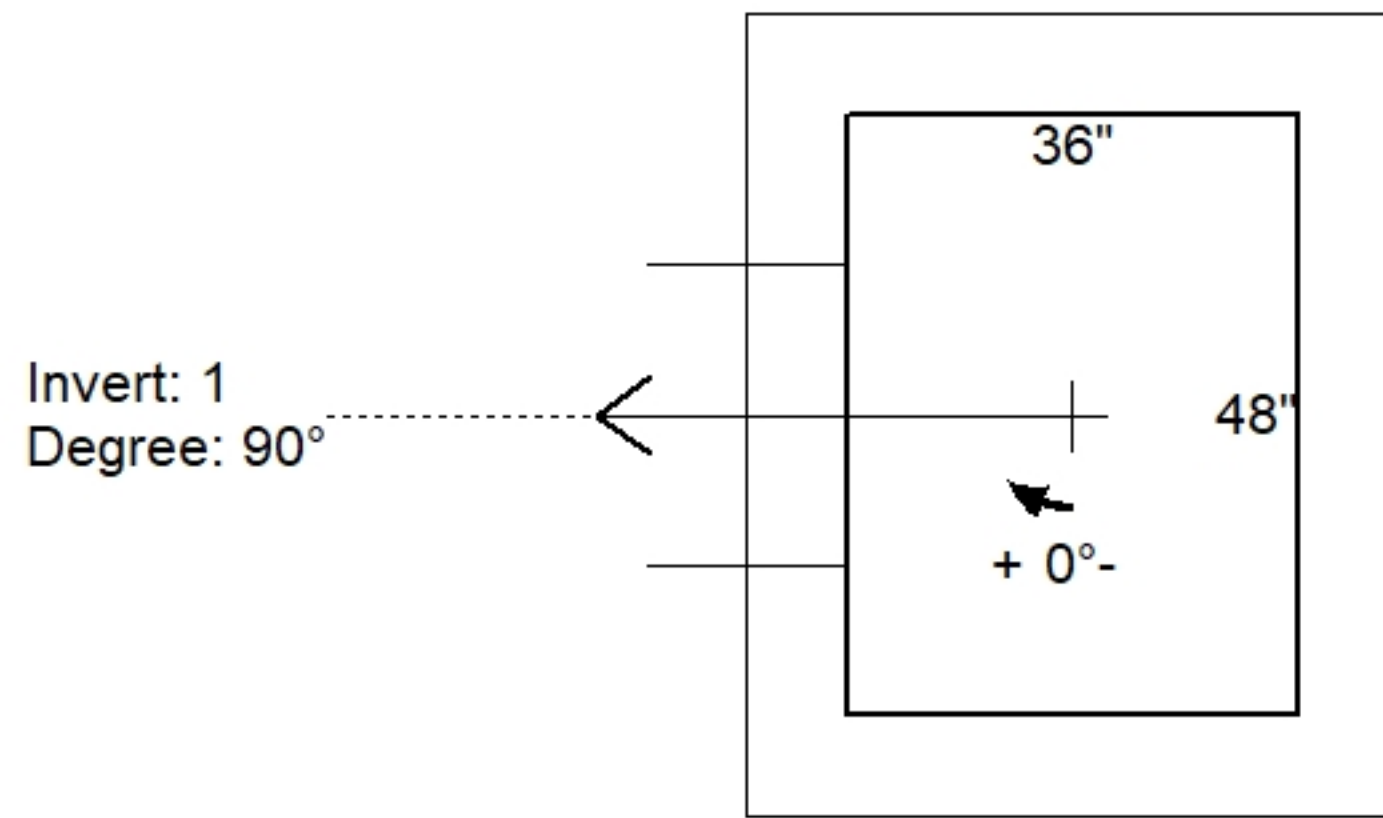

Position	Elev	Angle	Pipe	Pipe OD	Hole	Connector	Up ( )	Ref
Rim	479.35'							
Reducer								
Invert 1	476.6'	90°	18" HDPE	21.2"	24"	Hole 24	-3"	P1
Invert 2								
Invert 3								
Invert 4								
Invert 5								
Invert 6								
Invert 7								
Invert 8								

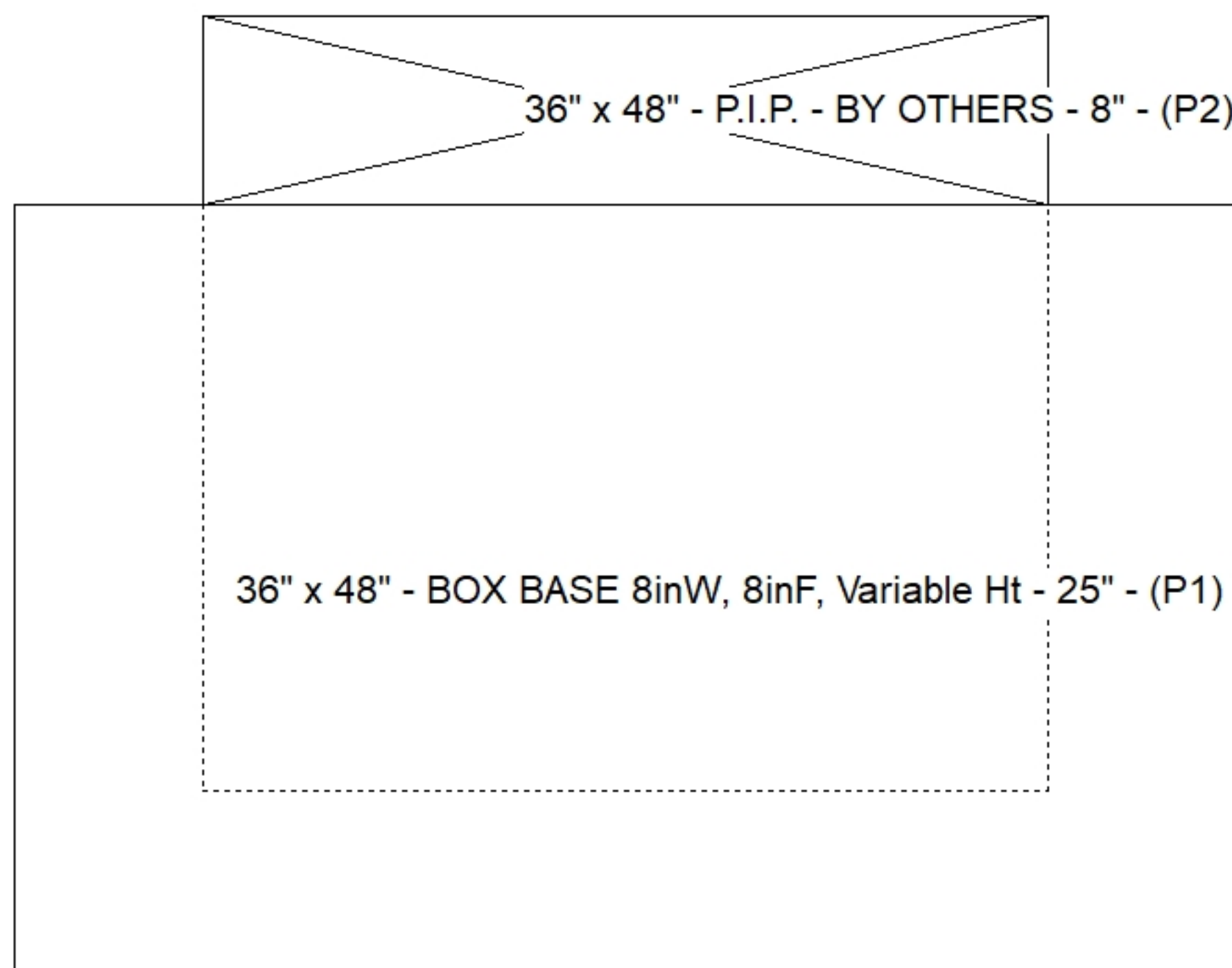

**Default - Interior Dimensions**

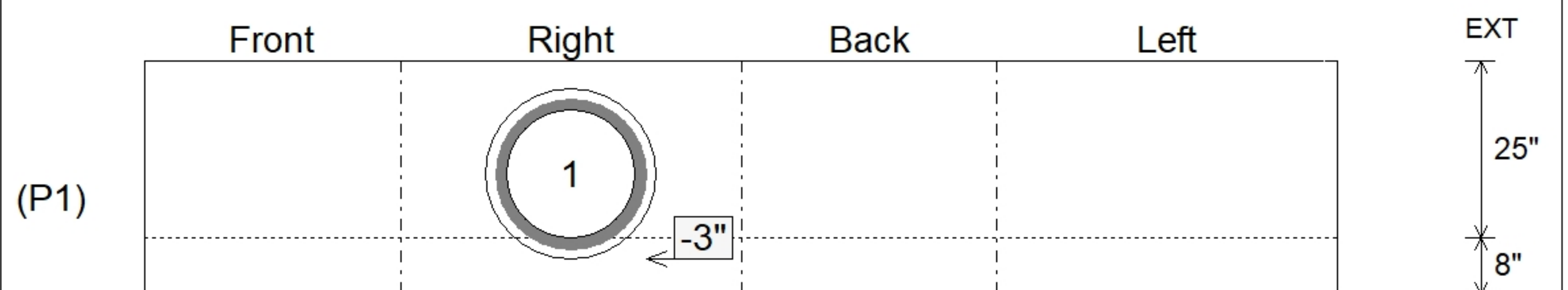

Submittal Drawing  
3/26/2026 8:40:04 AM

SUBMITTAL  
APPROVED BY: