

Job Name: 25-3480 - Noel Ave Sewer Improvements Ph 3
Job Location: Madisonville, KY 42431
Contractor: Luttrell & Sons, LLC

PC: Andy Chambers
 TECH: J. Horsley - A
 Plant: 100



Structure ID: **32+28**

Spec: Sanitary
 Type: SAN.MH w/Xypex
 Size: 60"

Rim: 7.25'
 Invert: 1'
 Rim to Invert: 6.25'

Sump: 12'
 Floor (Top): 0'
 Floor Height: 12"

Floor (Bot): -1'
 Overall Height: 8.25'
 Slack: 0"

Structure Notes:

- PER ASTM C-478 SPECIFICATIONS
- CONCRETE: 5,000 PSI AT 28 DAYS
- REINFORCEMENT:
 - FLAT LID: #5 BAR @ 6" C.C. E.W. (GRADE 60)
 - BASE WALLS: PER ASTM A615
 - BASE FLOOR: DBL MAT #5 BAR @ 6" C.C. E.W. (GRADE 60)
- NO STEPS
- XYPEX C-1000 ADMIXTURE REQUIRED
- HOE MC-375 FRAME & SELF-SEAL COVER "SANITARY" SUPPLIED BY ICAST
- INVERTS 1 & 2 OFFSET 6" FROM CENTER
- 48" DIA. OPENING REQUIRED THROUGH BASE FLOOR

STRUCTURE SUMMARY:

- P3) 24" - CASTING HEIGHT - 7" 0 lb
- P2) 60" - XYPEX MH FLAT TOP w/24" ECC Hole F/G - 13" 2701 lb
- P1) 60" - MH BASE w/FLANGE (12F/07EF) w/Xypex T/n - 67" 10813 lb
- 1) SECONDARY POUR - Extended Flange 0 lb
- 1) ADMIXTURE XYPEX C-1000 RED 0 lb
- 1) CASTING - HOE MC-375-SS F/C Sanitary 271 lb
- 1) 60" - Conseal CS-102 1.00" (Double) 0 lb
- 2) Hole - 16 0 lb
- Structure Total: 13785 lb**

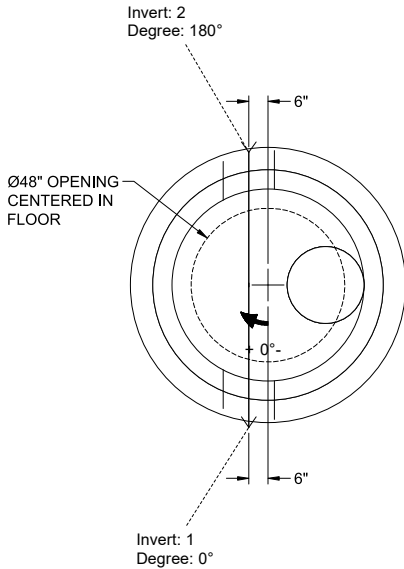

Position	Elev	Angle	Pipe	Pipe OD	Hole	Connector	Up ()	Ref
Rim	7.25'							
Reducer								
Invert 1	1'	0°	12" PVC SDR35	12.5"	16"	Hole 16	10"	P1
Invert 2	1'	180°	12" PVC SDR35	12.5"	16"	Hole 16	10"	P1
Invert 3								
Invert 4								
Invert 5								
Invert 6								
Invert 7								
Invert 8								

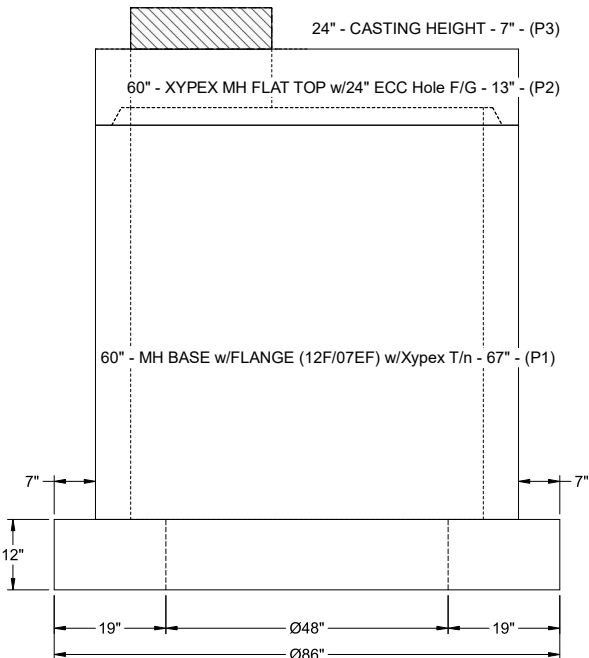

Cast (Int. Dim.) - Interior Dimensions

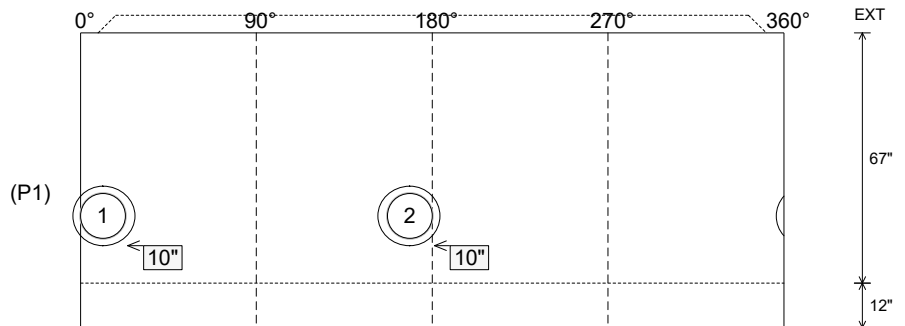

Submittal Drawing
 3/6/2026 5:53:52 AM

SUBMITTAL
 APPROVED BY: