

Job Name: 25-3480 - Noel Ave Sewer Improvements Ph 3
 Job Location: Madisonville, KY 42431
 Contractor: Luttrell & Sons, LLC

Plant: 100

3/6/2026 6:38:00 AM

Tech: J. Horsley - A

PC: Andy Chambers

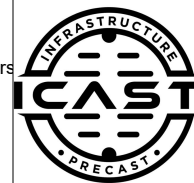

Structure ID: 3+12

P2 MH060LD13X

XYPEX MH FLAT TOP w/24" ECC Hole F/G

- P3) 24" - CASTING HEIGHT - 7"
- P2) 60" - XYPEX MH FLAT TOP w/24" ECC Hole F/G - 13"
- P1) 60" - MH BASE w/FLANGE (12F/07EF) w/Xypex T/n - 67"
- 1) SECONDARY POUR - Extended Flange
- 1) ADMIXTURE XYPEX C-1000 RED
- 1) CASTING - HOE MC-375-SS F/C Sanitary
- 1) 60" - Conseal CS-102 1.00" (Double)
- 2) Hole - 16

0 lb
 2701 lb
 10813 lb
 0 lb
 0 lb
 271 lb
 0 lb
 0 lb

 Structure Total: 13785 lb

- Structure Notes:
1. PER ASTM C-478 SPECIFICATIONS
 2. CONCRETE: 4,500 PSI AT 28 DAYS
 3. REINFORCEMENT: #5 BAR @ 6" C.C. E.W. (GRADE 60) - 2" MIN. REBAR CLEARANCE (TYP)
 4. XYPEX C-1000 ADMIXTURE REQUIRED
 5. HOE MC-375 FRAME & SELF-SEAL COVER "SANITARY" SUPPLIED BY ICAST
 6. LIFTERS: 3 EA. WRA016 CONAC WIRE ROPE ANCHORS FOR PLANT & FIELD HANDLING
 7. TOP SURFACE TO RECEIVE LIGHT BRUSH FINISH

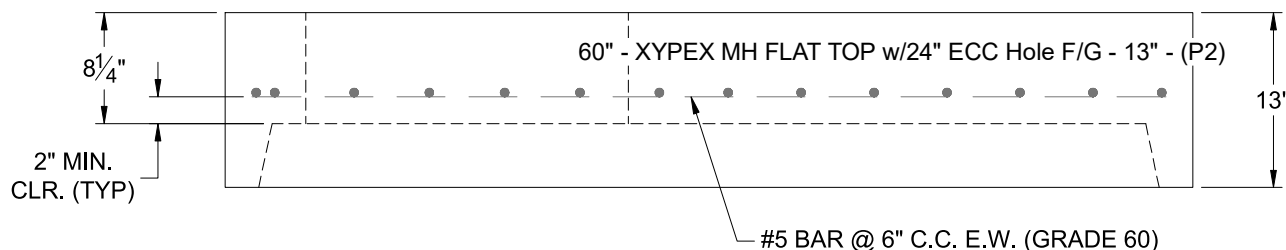
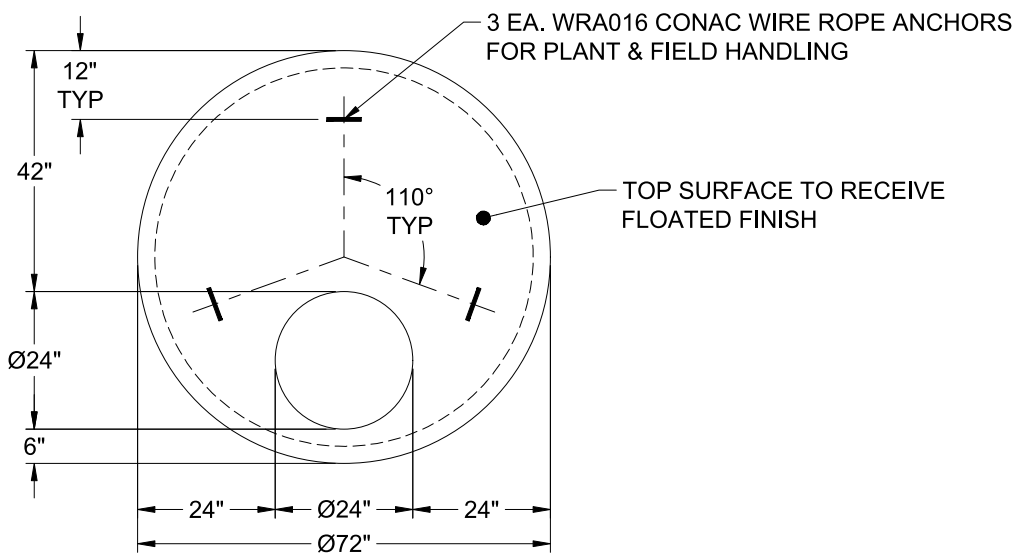

Coating (Int): Coating (Ext):	Seam Up: Flat Seam Dn: Groove	Wall Thickness: 6"	Height (Ext): 13"	Weight (Net): 2701 lb Volume (Net): 0.69cu.yd
----------------------------------	----------------------------------	--------------------	-------------------	--