

Job Name: 25-3480 - Noel Ave Sewer Improvements Ph 3
 Job Location: Madisonville, KY 42431
 Contractor: Luttrell & Sons, LLC

Plant: 100

3/6/2026 6:37:23 AM

Tech: J. Horsley - A

PC: Andy Chambers



Structure ID: 15-53480 (2)

P1 CTS

CUST. BASE SLAB (SOLID) F/F

P1) 72" x 72" - CUST. BASE SLAB (SOLID) F/F - 8"

Structure Total: 3480 lb

Structure Notes:

1. PER ASTM C-913 SPECIFICATIONS
2. CONCRETE: 4,500 PSI AT 28 DAYS
3. REINFORCEMENT: #5 BAR @ 8" C.C. E.W. (GRADE 60) - 2" MIN. REBAR CLEARANCE (TYP)
4. LIFTERS: 4 EA. 5CA14 CONAC A-ANCHORS FOR PLANT & FIELD HANDLING
5. TOP SURFACE TO RECEIVE LIGHT BRUSH FINISH

Rim: 0' Rim to Invert: 0' Slack: 0" Sump: 0" Step Position:

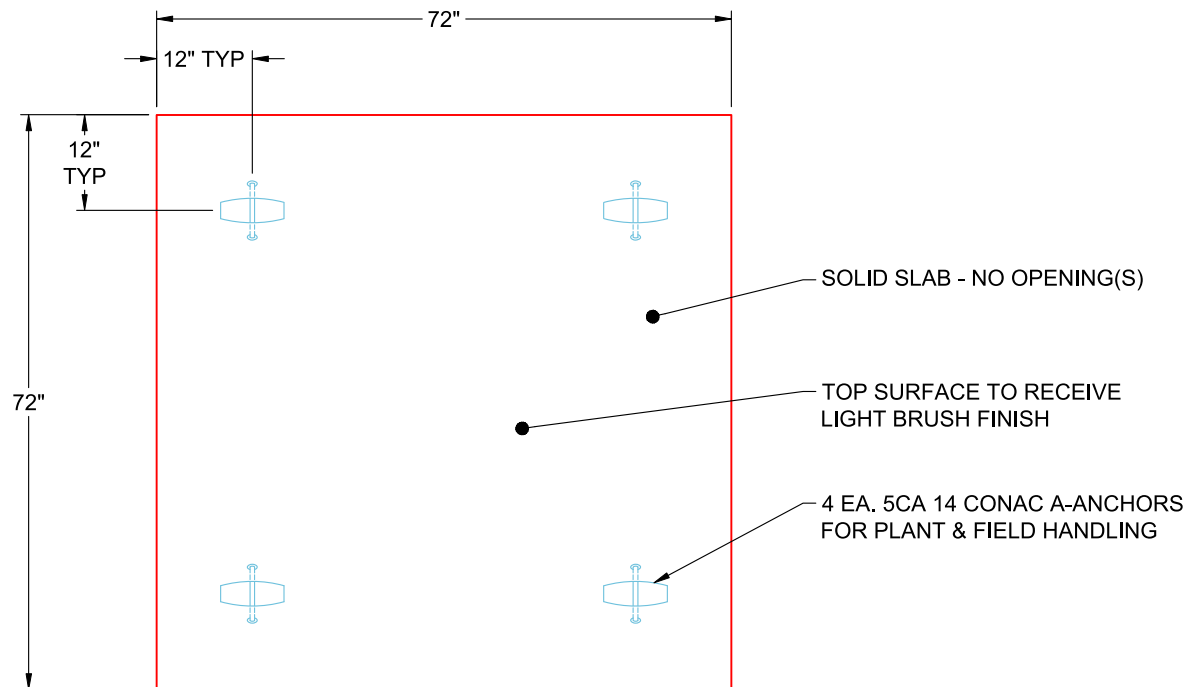

**PLAN VIEW
(RIGHT SIDE UP)**

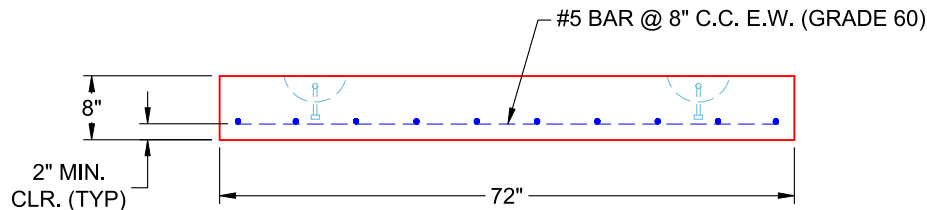

**FRONT VIEW
(RIGHT SIDE UP)**

Coating (Int):
Coating (Ext):

Seam Up: Flat
Seam Dn: Flat

Wall Thickness: 0"
Floor Height: 0"

Height (Int): 8"
Height (Ext): 8"

Weight (Net): 3480 lb
Volume (Net): 0.89cu.yd