

Job Name: 25-3480 - Noel Ave Sewer Improvements Ph 3
 Job Location: Madisonville, KY 42431
 Contractor: Luttrell & Sons, LLC

Plant: 100

3/6/2026 6:37:11 AM

Tech: J. Horsley - A

PC: Andy Chambers



Structure ID: 0+07

P1 MH060BAEVFX-12

MH BASE w/FLANGE (12F/07EF) w/Xypex T/n

- P3) 24" - CASTING HEIGHT - 7"
- P2) 60" - XYPEX MH FLAT TOP w/24" ECC Hole F/G - 13"
- P1) 60" - MH BASE w/FLANGE (12F/07EF) w/Xypex T/n - 67"
- 1) SECONDARY POUR - Extended Flange
- 1) ADMIXTURE XYPEX C-1000 RED
- 1) CASTING - HOE MC-375-SS F/C Sanitary
- 1) 60" - Conseal CS-102 1.00" (Double)
- 2) Hole - 16

0 lb
 2701 lb
 10813 lb
 0 lb
 0 lb
 271 lb
 0 lb
 0 lb

 13785 lb

Structure Total: 13785 lb

Structure Notes:

1. PER ASTM C-478 SPECIFICATIONS
2. CONCRETE: 5,000 PSI AT 28 DAYS
3. REINFORCEMENT:
 - WALLS: PER ASTM A615
 - FLOOR: DOUBLE MAT #5 BAR @ 6" C.C. E.W. (GRADE 60)
 - TOP MAT: 4" MIN. REBAR CLEARANCE
 - BOTTOM MAT: 3" MIN. REBAR CLEARANCE
4. NO STEPS
5. XYPEX C-1000 ADMIXTURE REQUIRED
6. HOE MC-375 FRAME & SELF-SEAL COVER "SANITARY" SUPPLIED BY ICAST
7. INVERTS 1 & 2 OFFSET 6" FROM CENTER
8. 48" DIA. OPENING REQUIRED THROUGH BASE FLOOR

FIRST POUR (BASE): 8,991 LBS
SECOND POUR (EXT. FLANGE): 1,822 LBS

Rim: 7.25' Rim to Invert: 6.25' Slack: 0" Sump: 12" Step Position:

Position	Elev	Angle	Ext. (cw)	Pipe	Pipe OD	Connector	Hole	Horz Size	Up ()	Offset
Invert 1	1'	0°	6"	12" PVC SDR35	12.5"	Hole 16	16"	16.567"	10"	6"
Invert 2	1'	180°	107.125"	12" PVC SDR35	12.5"	Hole 16	16"	16.567"	10"	-6"
Invert 3										
Invert 4										
Invert 5										
Invert 6										
Invert 7										
Invert 8										

RIGHT-SIDE UP VIEW (int. dimensions)

UPSIDE-DOWN VIEW (int. dimensions)

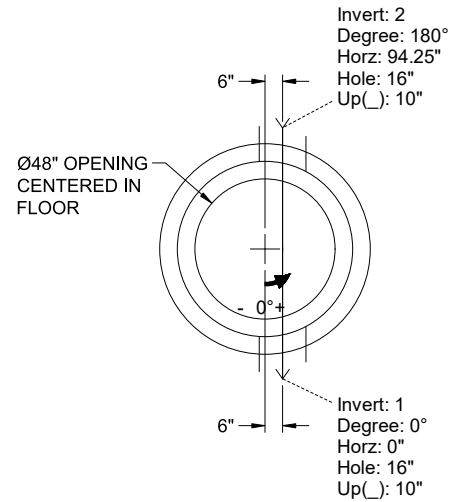
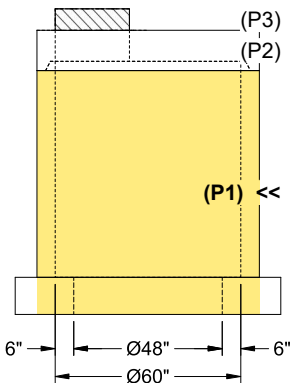

INSIDE WALL DIMENSIONS

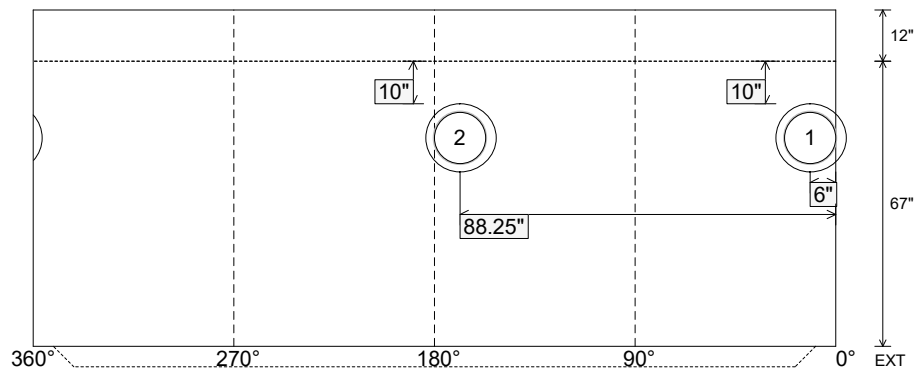

Coating (Int):
 Coating (Ext):

Seam Up: Tongue
 Seam Dn: n/a

Wall Thickness: 6"
 Floor Height: 12"

Height (Int): 67"
 Height (Ext): 79"

Weight (Net): 10813 lb
 Volume (Net): 2.76cu.yd

Job Name: 25-3480 - Noel Ave Sewer Improvements Ph 3
 Job Location: Madisonville, KY 42431
 Contractor: Luttrell & Sons, LLC

Plant: 100

3/6/2026 6:37:11 AM

Tech: J. Horsley - A

PC: Andy Chambers



Structure ID: 0+07

P1 MH060BAEVFX-12

MH BASE w/FLANGE (12F/07EF) w/Xypex T/n

- P3) 24" - CASTING HEIGHT - 7"
- P2) 60" - XYPEX MH FLAT TOP w/24" ECC Hole F/G - 13"
- P1) 60" - MH BASE w/FLANGE (12F/07EF) w/Xypex T/n - 67"
- 1) SECONDARY POUR - Extended Flange
- 1) ADMIXTURE XYPEX C-1000 RED
- 1) CASTING - HOE MC-375-SS F/C Sanitary
- 1) 60" - Conseal CS-102 1.00" (Double)
- 2) Hole - 16

0 lb
 2701 lb
 10813 lb
 0 lb
 0 lb
 271 lb
 0 lb
 0 lb

 13785 lb

Structure Total: 13785 lb

Structure Notes:

1. PER ASTM C-478 SPECIFICATIONS
2. CONCRETE: 5,000 PSI AT 28 DAYS
3. REINFORCEMENT: DRILL & DOWEL DOUBLE MAT #5 BAR SPACED @ 8" C.C. (GRADE 60) OUT OF BASE FLOOR FOR FLANGE POUR TIE-IN - MIN. 4" PENETRATION INTO BASE FLOOR & 2" MIN. REBAR CLEARANCE (TYP)
4. NO STEPS
5. XYPEX C-1000 ADMIXTURE REQUIRED
6. HOE MC-375 FRAME & SELF-SEAL COVER "SANITARY" SUPPLIED BY ICAST

FIRST POUR (BASE): 8,991 LBS
SECOND POUR (EXT. FLANGE): 1,822 LBS

Rim: 7.25' Rim to Invert: 6.25' Slack: 0" Sump: 12" Step Position:

Position	Elev	Angle	Ext. (cw)	Pipe	Pipe OD	Connector	Hole	Horz Size	Up ()	Offset
Invert 1	1'	0°	6"	12" PVC SDR35	12.5"	Hole 16	16"	16.567"	10"	6"
Invert 2	1'	180°	107.125"	12" PVC SDR35	12.5"	Hole 16	16"	16.567"	10"	-6"
Invert 3										
Invert 4										
Invert 5										
Invert 6										
Invert 7										
Invert 8										

RIGHT-SIDE UP VIEW (int. dimensions)

UPSIDE-DOWN VIEW (int. dimensions)

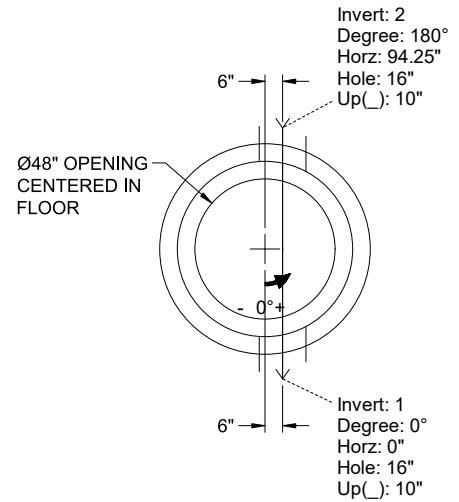
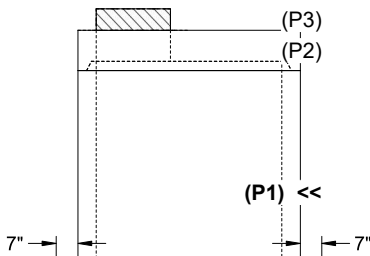

INSIDE WALL DIMENSIONS

DRILL & DOWEL DOUBLE MAT #5 BAR SPACED @ 12" C.C. (GRADE 60) OUT OF BASE FLOOR FOR FLANGE POUR TIE-IN - MIN. 4" PENETRATION INTO BASE FLOOR & 2" MIN. REBAR CLEARANCE (TYP)

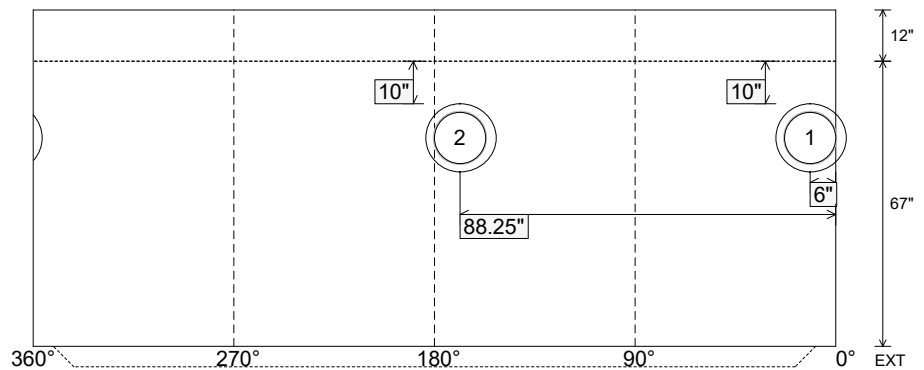

Coating (Int):
 Coating (Ext):

Seam Up: Tongue
 Seam Dn: n/a

Wall Thickness: 6"
 Floor Height: 12"

Height (Int): 67"
 Height (Ext): 79"

Weight (Net): 10813 lb
 Volume (Net): 2.76cu.yd