

Job Name: 25-3333 Canon Court
 Job Location: Dawson Springs, KY
 Contractor: J & J Excavating

Plant: 100

11/19/2025 6:27:01 PM

Tech: J. Horsley -F

PC: A. Chambers



Structure ID: SSMH 1-3

P2 MH048CN36

ECC CONE w/ 24" HOLE F/G

P4) 24" - CASTING HEIGHT - 7"	0 lb
P3) 24" - GRADE RING F/F - 4"	270 lb
P2) 48" - ECC CONE w/ 24" HOLE F/G - 36"	3000 lb
P1) 48" - MH BASE T/n - 24"	2911 lb
1) 48" - MH INVERT CHANNEL - FULL HEIGHT	1440 lb
1) JOINT WRAP - 0.065"x6"x50' CONSEAL CS212	0 lb
1) JOINT WRAP PRIMER - CONSEAL CS-75 (1 gal.)	0 lb
1) CASTING - HOE MC-375 F/C Sanitary	271 lb
1) 48" - Conseal CS-102 1.00" (Double)	0 lb
2) PSX - 12-08 NYLO	16 lb
4) MH Step ML-10-TDS-NCR - 10"	0 lb
Structure Total:	7908 lb

Structure Notes:
 1. PER ASTM C478 SPECIFICATIONS.
 2. CONCRETE = 4,000 PSI AT 28 DAYS.
 3. CASTING BY ICAST (HOE MC-375 "SANITARY" F/C).

 REINFORCING PER ASTM A615 (GRADE 60).
 - CONE (As .12)
 - RISER/WALLS (As .12)
 - FLOOR (As .31) #5 BARS AT 12" C.C.E.W.

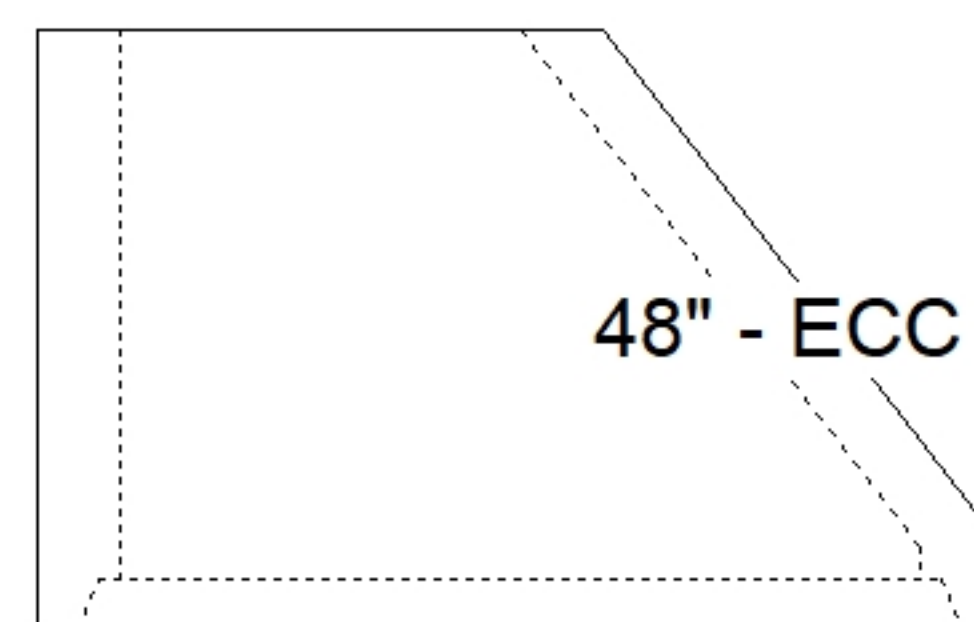
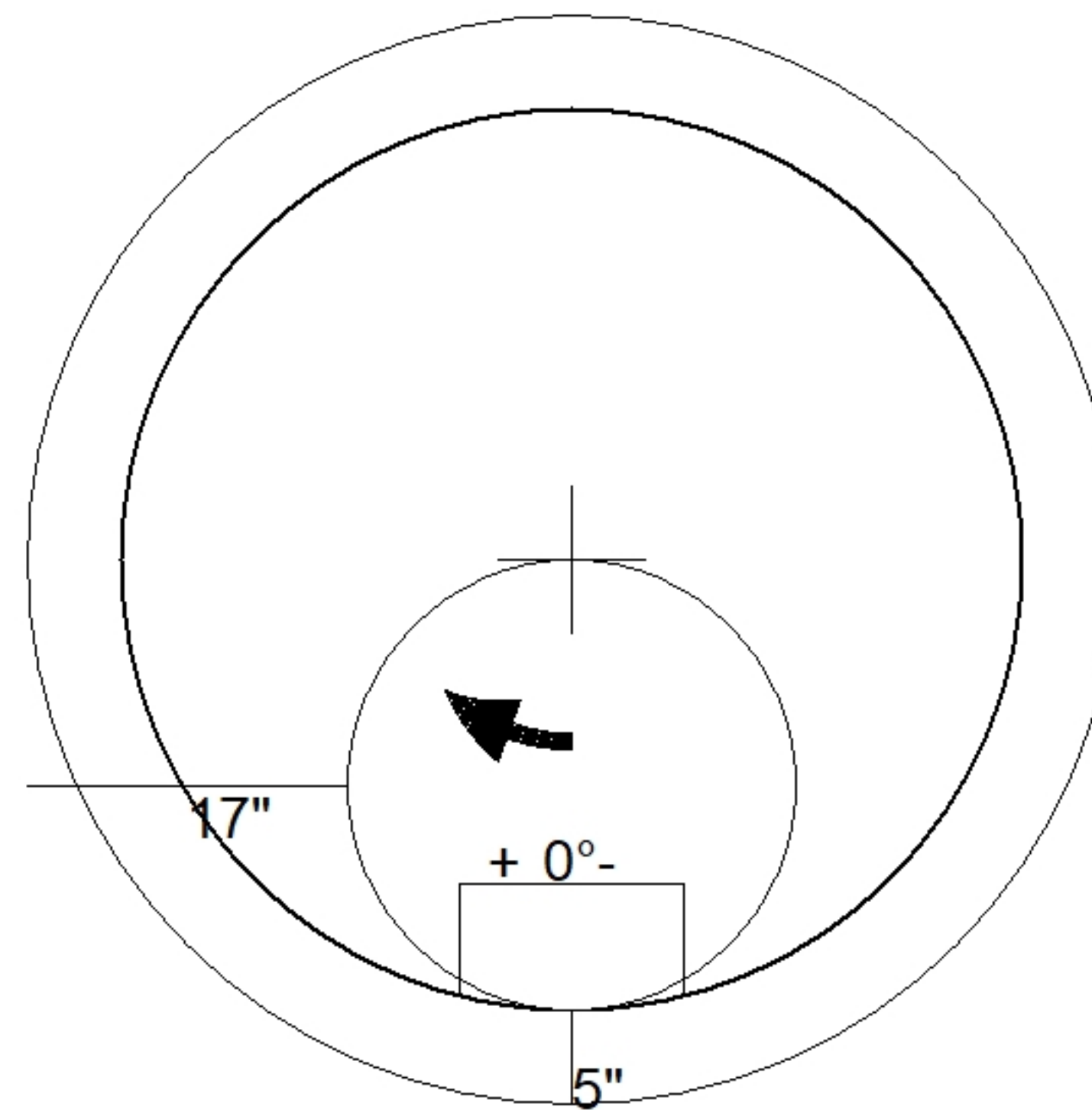

48" - ECC CONE w/ 24" HOLE F/G - 36" - (P2)

Coating (Int): Coating (Ext):	Seam Up: Flat Seam Dn: Groove	Wall Thickness: 5"	Height (Ext): 36"	Weight (Net): 3000 lb Volume (Net): 0.5cu.yd
----------------------------------	----------------------------------	--------------------	-------------------	---