

Job Name: 25-3118 - W6 Ph 2-C Force Main Improvements
 Job Location: Fort Mitchell, KY 41017
 Contractor: Lykins Contracting

Plant: 100

3/27/2026 11:40:13 AM

Tech: J. Horsley - A

PC: Celina Goff



Structure ID: 2301549

P4 MH048CCN36

CON CONE w/24" HOLE F/G

- P5) 24" - CASTING HEIGHT - 7"
- P4) 48" - CON CONE w/24" HOLE F/G - 36"
- P3) 48" - MH RISER T/G - 36"
- P2) 60" - MH Transition Slab 48" Hole T/G - 15"
- P1) 60" - MH BASE Custom Ht T/n - 68"
- 1) 60" - MH INVERT CHANNEL - FULL HEIGHT
- 1) 60" - Conseal CS-102 1.00" (Double)
- 2) 48" - Conseal CS-102 1.00" (Double)
- 2) A-Lok - 1235
- 11) MH Step ML-10-TDS-NCR - 10"

0 lb
2252 lb
2515 lb
2204 lb
8477 lb
2692 lb
0 lb
0 lb
2 lb
0 lb

Structure Total: 18143 lb

- Structure Notes:
1. PER ASTM C-478 SPECIFICATIONS
 2. CONCRETE: 4,000 PSI AT 28 DAYS
 3. REINFORCEMENT: PER ASTM A615
 4. STEPS REQUIRED
 5. 7" CASTING SUPPLIED BY OTHERS

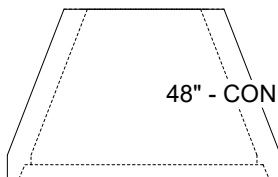
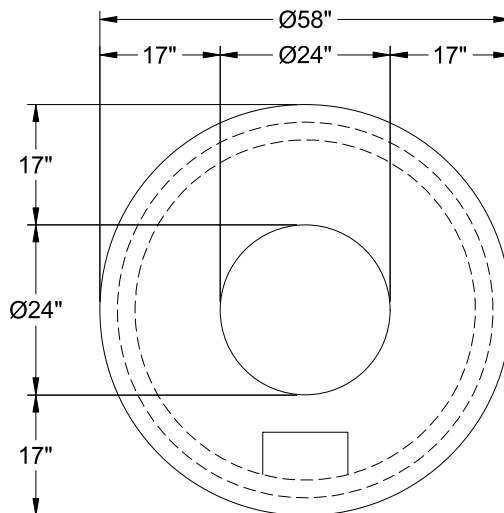

48" - CON CONE w/24" HOLE F/G - 36" - (P4)

Coating (Int):
 Coating (Ext):

Seam Up: Flat
 Seam Dn: Groove

Wall Thickness: 5"

Height (Ext): 36"

Weight (Net): 2252 lb
 Volume (Net): 0.57cu.yd