

Job Name: 25-3118 - W6 Ph 2-C Force Main Improvements  
 Job Location: Fort Mitchell, KY 41017  
 Contractor: Lykins Contracting

Plant: 100

Tech: J. Horsley - A

3/26/2026 2:14:38 PM

PC: Celina Goff



**Structure ID: 2301542**

**P2 MH060R60**

**MH RISER w/DROP T/G**

- P6) 24" - CASTING HEIGHT - 7"
- P5) 48" - CON CONE w/24" HOLE F/G - 24"
- P4) 48" - MH RISER T/G - 48"
- P3) 60" - MH Transition Slab 48" Hole T/G - 15"
- P2) 60" - MH RISER w/DROP T/G - 60"
- P1) 60" - MH BASE (10" F) w/DROP Custom Ht T/n - 59"
- 1) 60" - MH INVERT CHANNEL - FULL HEIGHT
- 1) SECONDARY POUR - Add Exterior Drop to Base (P1)
- 1) SECONDARY POUR - Add Exterior Drop to Riser (P2)
- 2) 60" - Conseal CS-102 1.00" (Double)
- 2) 48" - Conseal CS-102 1.00" (Double)
- 2) A-Lok - 1235
- 1) Drop Tee - 8" PVC
- 1) Drop Elbow - 8" PVC
- 16) MH Step ML-10-TDS-NCR - 10"

- 0 lb
- 2252 lb
- 3353 lb
- 2204 lb
- 6235 lb
- 11159 lb
- 2692 lb
- 2967 lb
- 2580 lb
- 0 lb
- 0 lb
- 2 lb
- 0 lb
- 0 lb
- 0 lb
- 0 lb
- 
- 33444 lb

**Structure Notes:**  
 1. PER ASTM C-478 SPECIFICATIONS  
 2. CONCRETE: 4,000 PSI AT 28 DAYS  
 3. REINFORCEMENT: PER ASTM A615  
 4. STEPS AT 90 DEGREES  
 5. 7" CASTING SUPPLIED BY OTHERS  
 6. EXTERIOR DROP AT INVERTS 3 & 4 SUPPLIED BY ICAST

Structure Total: 33444 lb

**FIRST POUR (RISER): 6,235 LBS**  
**SECOND POUR (DROP): 2,580 LBS**

Rim: 751.38' Rim to Invert: 17.53' Slack: 0.36" Sump: 3" Step Position: 90°

Position	Elev	Angle	Ext. (cw)	Pipe	Pipe OD	Connector	Hole	Horz Size	Up ( )	Offset
Invert 1										
Invert 2										
Invert 3	742.06'	270°	169.625"	8" PVC SDR35	8.5"	Drop Tee 8" PVC	8.5"	8.529"	37.5"	0"
Invert 4										
Invert 5										
Invert 6										
Invert 7										
Invert 8										

**RIGHT-SIDE UP VIEW (int. dimensions)**

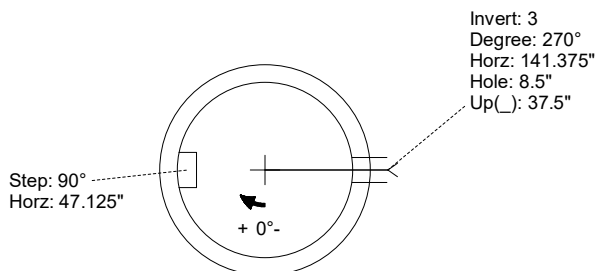
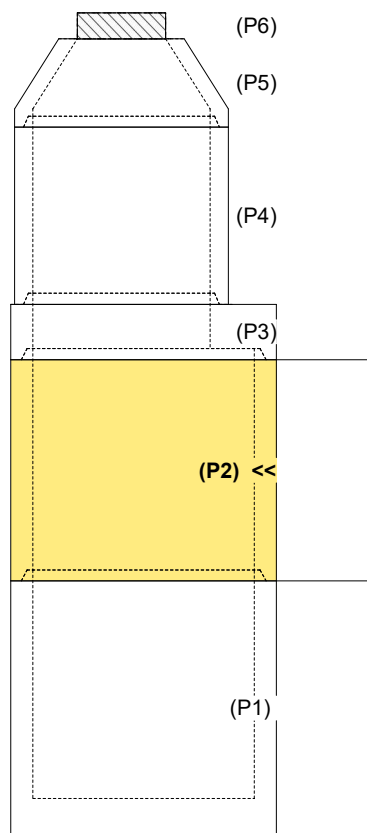

**INSIDE WALL DIMENSIONS**

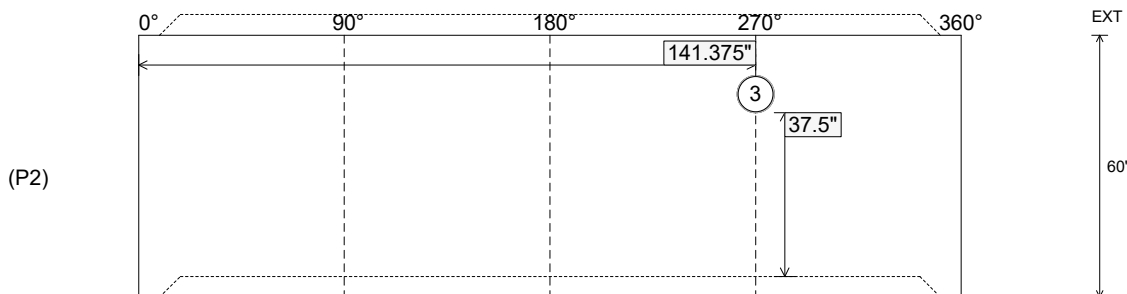

Coating (Int):  
 Coating (Ext):

Seam Up: Tongue  
 Seam Dn: Groove

Wall Thickness: 6"  
 Floor Height: 0"

Height (Int): 60"  
 Height (Ext): 60"

Weight (Net): 6235 lb  
 Volume (Net): 1.59cu.yd

Job Name: 25-3118 - W6 Ph 2-C Force Main Improvements  
 Job Location: Fort Mitchell, KY 41017  
 Contractor: Lykins Contracting

Plant: 100

3/26/2026 2:14:38 PM

Tech: J. Horsley - A

PC: Celina Goff

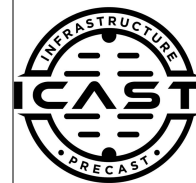

**Structure ID: 2301542**

**P2 MH060R60**

**MH RISER w/DROP T/G**

- P6) 24" - CASTING HEIGHT - 7"
- P5) 48" - CON CONE w/24" HOLE F/G - 24"
- P4) 48" - MH RISER T/G - 48"
- P3) 60" - MH Transition Slab 48" Hole T/G - 15"
- P2) 60" - MH RISER w/DROP T/G - 60"
- P1) 60" - MH BASE (10"F) w/DROP Custom Ht T/n - 59"
- 1) 60" - MH INVERT CHANNEL - FULL HEIGHT
- 1) SECONDARY POUR - Add Exterior Drop to Base (P1)
- 1) SECONDARY POUR - Add Exterior Drop to Riser (P2)
- 2) 60" - Conseal CS-102 1.00" (Double)
- 2) 48" - Conseal CS-102 1.00" (Double)
- 2) A-Lok - 1235
- 1) Drop Tee - 8" PVC
- 1) Drop Elbow - 8" PVC
- 16) MH Step ML-10-TDS-NCR - 10"

0 lb  
 2252 lb  
 3353 lb  
 2204 lb  
 6235 lb  
 11159 lb  
 2692 lb  
 2967 lb  
 2580 lb  
 0 lb  
 0 lb  
 2 lb  
 0 lb  
 0 lb  
 0 lb  
 0 lb  
 -----  
 Structure Total: 33444 lb

- Structure Notes:**
1. PER ASTM C-478 SPECIFICATIONS
  2. CONCRETE: 4,000 PSI AT 28 DAYS
  3. EXTERIOR DROP REINFORCEMENT: DRILL & STUB #4 BAR @ 12" C.C. E.W. (GRADE 60) - 2" MIN. REBAR CLEARANCE (TYP)
  4. STEPS AT 90 DEGREES
  5. 7" CASTING SUPPLIED BY OTHERS
  6. EXTERIOR DROP AT INVERTS 3 & 4 SUPPLIED BY ICAST
  7. ADD 8" SDR 35 DROP & TEE AT INVERT 3 (270°)

**FIRST POUR (RISER): 6,235 LBS**

**SECOND POUR (DROP): 2,580 LBS**

Rim: 751.38' Rim to Invert: 17.53' Slack: 0.36" Sump: 3" Step Position: 90°

Position	Elev	Angle	Ext. (cw)	Pipe	Pipe OD	Connector	Hole	Horz Size	Up ( )	Offset
Invert 1										
Invert 2										
Invert 3	742.06'	270°	169.625"	8" PVC SDR35	8.5"	Drop Tee 8" PVC	8.5"	8.529"	37.5"	0"
Invert 4										
Invert 5										
Invert 6										
Invert 7										
Invert 8										

**RIGHT-SIDE UP VIEW (int. dimensions)**

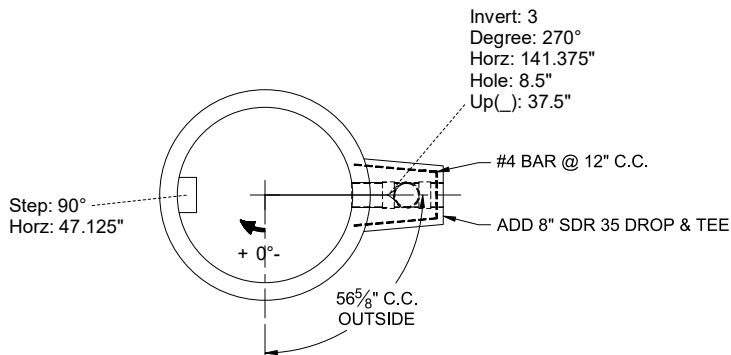
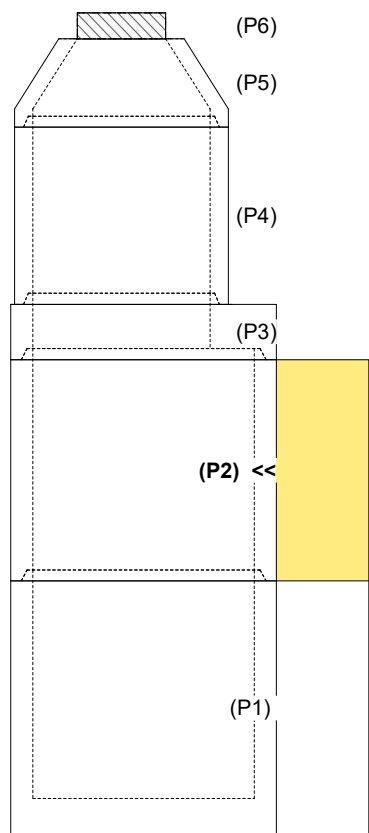

**INSIDE WALL DIMENSIONS**

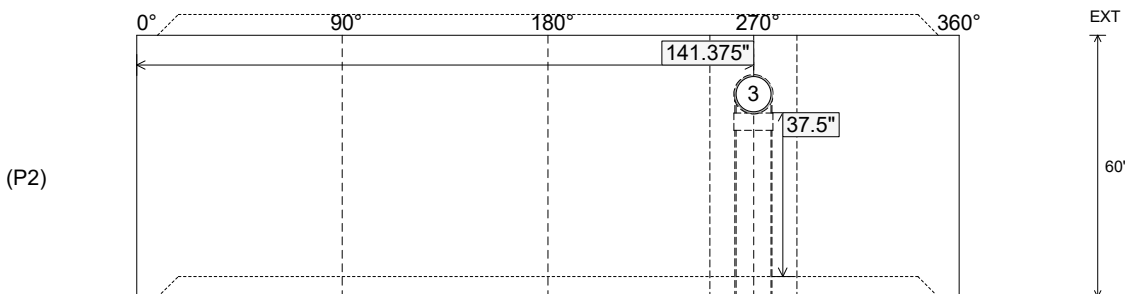

Coating (Int):  
 Coating (Ext):

Seam Up: Tongue  
 Seam Dn: Groove

Wall Thickness: 6"  
 Floor Height: 0"

Height (Int): 60"  
 Height (Ext): 60"

Weight (Net): 6235 lb  
 Volume (Net): 1.59cu.yd