

Job Name: 25-3118 - W6 Ph 2-C Force Main Improvements
Job Location: Fort Mitchell, KY 41017
Contractor: Lykins Contracting

PC: Celina Goff
 TECH: J. Horsley - A
 Plant: 100



Structure ID: **2301530**
 Spec: Sanitary
 Type: SAN.MH Transition
 Size: 60"

Rim: 741.85'
 Invert: 729.32'
 Rim to Invert: 12.53'

Sump: 3"
 Floor (Top): 729.07'
 Floor Height: 8"

Floor (Bot): 728.403'
 Overall Height: 13.25'
 Slack: 2.36"

Structure Notes:

1. PER ASTM C-478 SPECIFICATIONS
2. CONCRETE: 4,000 PSI AT 28 DAYS
3. REINFORCEMENT:
 - CONE & RISER: PER ASTM A615
 - TRANSITION SLAB: #5 BAR @ 6" C.C. E.W. (GRADE 60)
 - BASE WALLS: PER ASTM A615 - DOUBLE MAT
 - BASE FLOOR: #5 BAR @ 12" C.C. E.W. (GRADE 60)
4. INVERT CHANNEL REQUIRED
5. STEPS AT 90 DEGREES
6. 7" CASTING SUPPLIED BY OTHERS

STRUCTURE SUMMARY:

P5) 24" - CASTING HEIGHT - 7"	0 lb
P4) 48" - CON CONE w/24" HOLE F/G - 24"	2252 lb
P3) 48" - MH RISER T/G - 36"	2515 lb
P2) 60" - MH Transition Slab 48" Hole T/G - 15"	2204 lb
P1) 60" - MH BASE Custom Ht T/n - 69"	8582 lb
1) 60" - MH INVERT CHANNEL - FULL HEIGHT	2692 lb
1) 60" - Conseal CS-102 1.00" (Double)	0 lb
2) 48" - Conseal CS-102 1.00" (Double)	0 lb
2) A-Lok - 1235	2 lb
11) MH Step ML-10-TDS-NCR - 10"	0 lb
Structure Total:	18247 lb

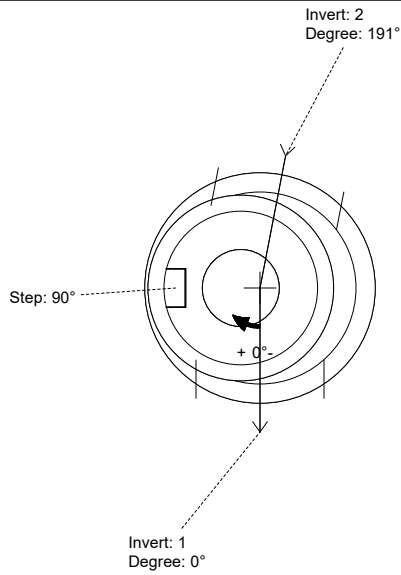

Position	Elev	Angle	Pipe	Pipe OD	Hole	Connector	Up (L)	Ref
Rim	741.85'							
Reducer	734.82'							
Invert 1	729.32'	0°	36" PVC SDR35/F679	38.3"	39.88"	A-Lok 1235	1.125"	P1
Invert 2	729.42'	191°	36" PVC SDR35/F679	38.3"	39.88"	A-Lok 1235	2.25"	P1
Invert 3								
Invert 4								
Invert 5								
Invert 6								
Invert 7								
Invert 8								

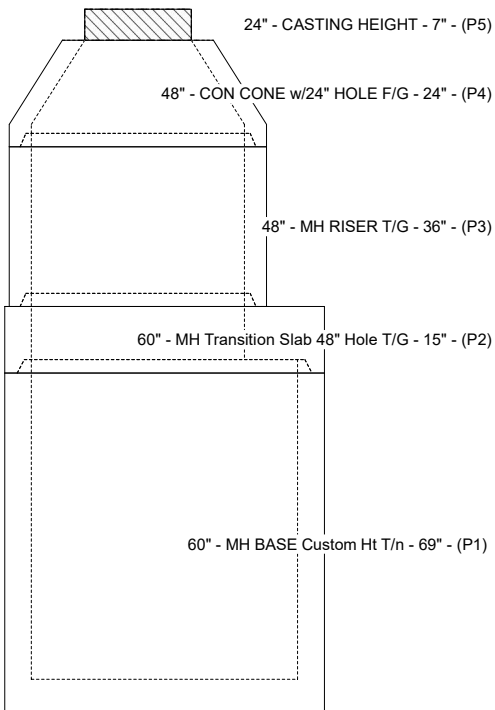

Cast (Int. Dim.) - Interior Dimensions

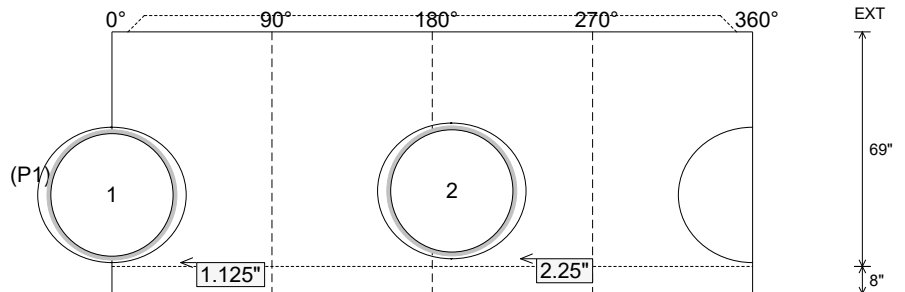

Submittal Drawing
 3/17/2026 12:34:47 PM

SUBMITTAL
 APPROVED BY: