

Job Name: 25-3118 - W6 Ph 2-C Force Main Improvements
 Job Location: Fort Mitchell, KY 41017
 Contractor: Lykins Contracting

Plant: 100

3/27/2026 11:39:19 AM

Tech: J. Horsley - A

PC: Celina Goff



Structure ID: 2301530

P2 MH060TS15-48ECC

MH Transition Slab 48" Hole T/G

- P5) 24" - CASTING HEIGHT - 7"
- P4) 48" - CON CONE w/24" HOLE F/G - 24"
- P3) 48" - MH RISER T/G - 36"
- P2) 60" - MH Transition Slab 48" Hole T/G - 15"
- P1) 60" - MH BASE Custom Ht T/n - 69"
- 1) 60" - MH INVERT CHANNEL - FULL HEIGHT
- 1) 60" - Conseal CS-102 1.00" (Double)
- 2) 48" - Conseal CS-102 1.00" (Double)
- 2) A-Lok - 1235
- 11) MH Step ML-10-TDS-NCR - 10"

0 lb
2252 lb
2515 lb
2204 lb
8582 lb
2692 lb
0 lb
0 lb
2 lb
0 lb

Structure Total: 18247 lb

- Structure Notes:
1. PER ASTM C-478 SPECIFICATIONS
 2. CONCRETE: 4,000 PSI AT 28 DAYS
 3. REINFORCEMENT - 2" MIN. REBAR CLEARANCE (TYP):
 - TOP MAT: #4 BAR @ 18" C.C. E.W. (GRADE 60)
 - BOTTOM MAT: #4 BAR @ 9" C.C. E.W. (GRADE 60)
 4. 7" CASTING SUPPLIED BY OTHERS
 5. LIFTERS: 3 EA. WRA016 CONAC WIRE ROPE ANCHORS FOR PLANT & FIELD HANDLING
 6. TOP SURFACE TO RECEIVE FLOATED FINISH

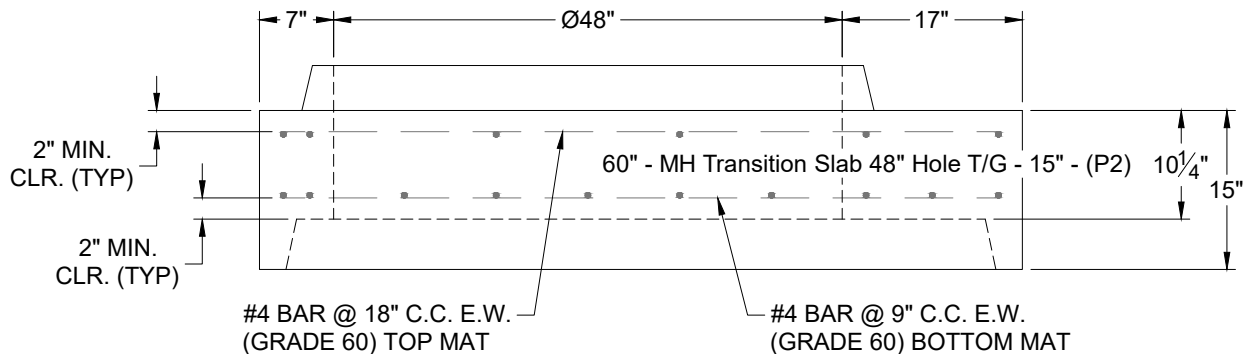
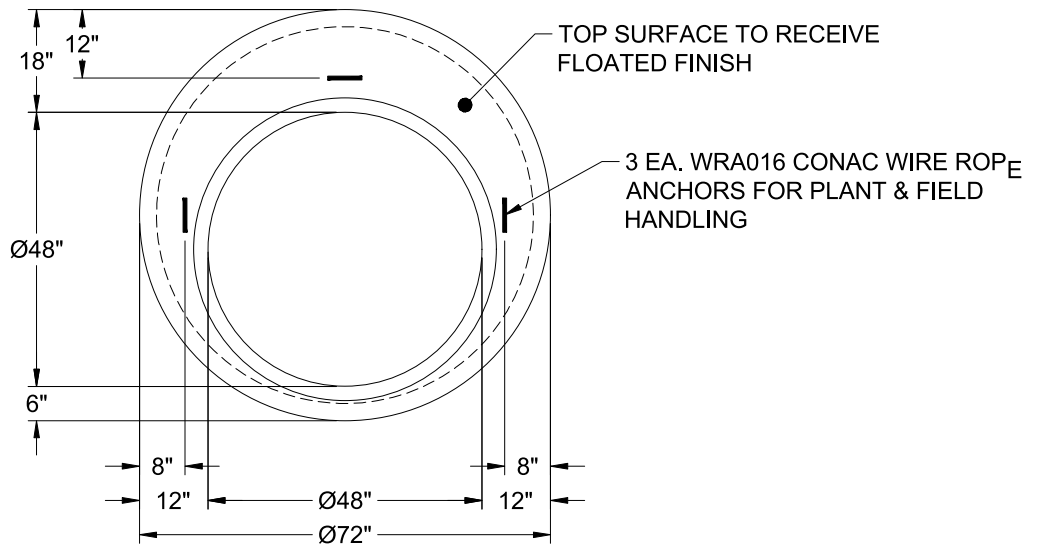

Coating (Int):
Coating (Ext):

Seam Up: Tongue
Seam Dn: Groove

Wall Thickness: 6"

Height (Ext): 15"

Weight (Net): 2204 lb
Volume (Net): 0.56cu.yd