

Job Name: 25-3118 - W6 Ph 2-C Force Main Improvements
Job Location: Fort Mitchell, KY 41017
Contractor: Lykins Contracting

PC: Celina Goff
 TECH: J. Horsley - A
 Plant: 100



Structure ID: **2280821**
 Spec: Sanitary
 Type: SAN.MH
 Size: 48"

Rim: 774.3'
 Invert: 762.55'
 Rim to Invert: 11.75'

Sump: 2.309"
 Floor (Top): 762.358'
 Floor Height: 8"

Floor (Bot): 761.691'
 Overall Height: 12.417'
 Slack: 2.309"

- Structure Notes:**
- PER ASTM C-478 SPECIFICATIONS
 - CONCRETE: 4,000 PSI AT 28 DAYS
 - REINFORCEMENT:
 - CONE & RISER: PER ASTM A615
 - BASE WALLS: PER ASTM A615 - DOUBLE MAT
 - BASE FLOOR: #5 BAR @ 12" C.C. E.W. (GRADE 60)
 - INVERT CHANNEL REQUIRED
 - STEPS AT 270 DEGREES
 - 7" CASTING SUPPLIED BY OTHERS

STRUCTURE SUMMARY:

P4) 24" - CASTING HEIGHT - 7"	0 lb
P3) 48" - CON CONE w/24" HOLE F/G - 36"	2252 lb
P2) 48" - MH RISER T/G - 48"	3353 lb
P1) 48" - MH BASE (08"F) T/n - 50"	4721 lb
1) 48" - MH INVERT CHANNEL - FULL HEIGHT	1440 lb
2) 48" - Conseal CS-102 1.00" (Double)	0 lb
2) Kor-N-Seal2 - S206-28	13 lb
9) MH Step ML-10-TDS-NCR - 10"	0 lb
Structure Total:	11780 lb

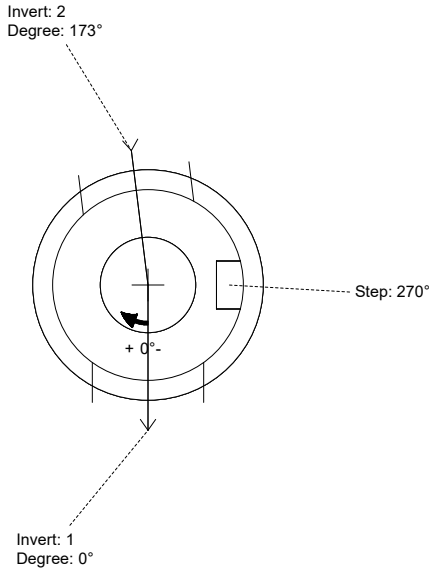

Position	Elev	Angle	Pipe	Pipe OD	Hole	Connector	Up (")	Ref
Rim	774.3'							
Reducer								
Invert 1	762.55'	0°	24" PVC SDR35/F679	24.803"	28"	Kor-N-Seal2 S206-28	0"	P1
Invert 2	762.65'	173°	24" PVC SDR35/F679	24.803"	28"	Kor-N-Seal2 S206-28	1.25"	P1
Invert 3								
Invert 4								
Invert 5								
Invert 6								
Invert 7								
Invert 8								

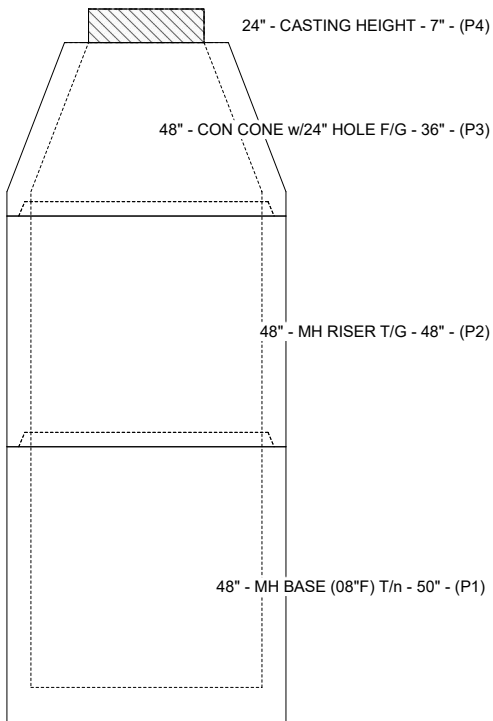

Cast (Int. Dim.) - Interior Dimensions

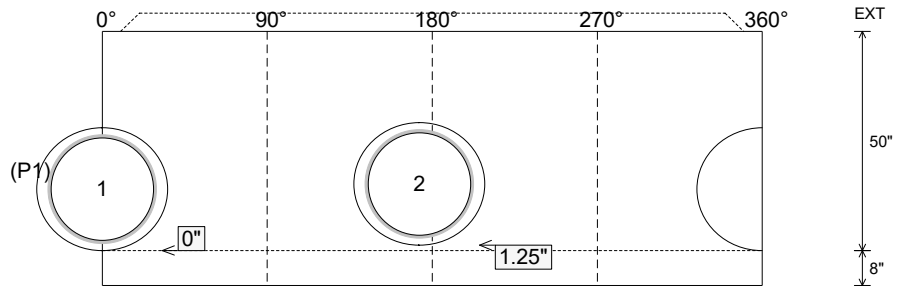

Submittal Drawing
 3/17/2026 12:36:24 PM

SUBMITTAL
 APPROVED BY: