

Job Name: 25-2991 BHS Addition & Renovation Ph 2
 Job Location: Bardstown, KY
 Contractor: Parker Excavating, LLC

Plant: 100
 1/14/2026 9:50:13 AM

Tech: J. Horsley - A
 PC: Erica Bradley



Structure ID: 9B

P2 MH048CN36

ECC CONE w/ 24" HOLE F/G

- P3) 24" - CASTING HEIGHT - 7"
- P2) 48" - ECC CONE w/ 24" HOLE F/G - 36"
- P1) 48" - MH BASE T/n - 42"
- 1) CASTING - HOE MC-315 F/C Storm
- 1) 48" - Conseal CS-102 1.00"
- 2) Hole - 30
- 6) MH Step ML-10-TDS-NCR - 10"

0 lb
 3000 lb
 3632 lb
 258 lb
 0 lb
 0 lb
 0 lb

 6890 lb

Structure Total:

- Structure Notes:
1. PER ASTM C-478 SPECIFICATIONS
 2. CONCRETE: 4,000 PSI AT 28 DAYS
 3. REINFORCEMENT: PER ASTM A615
 4. NO STORM INVERT
 5. STEPS AT 240 DEGREES
 6. HOE MC-315 FRAME & COVER "STORM" SUPPLIED BY ICAST

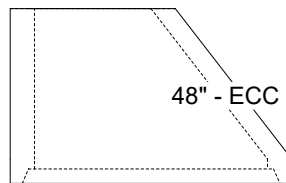
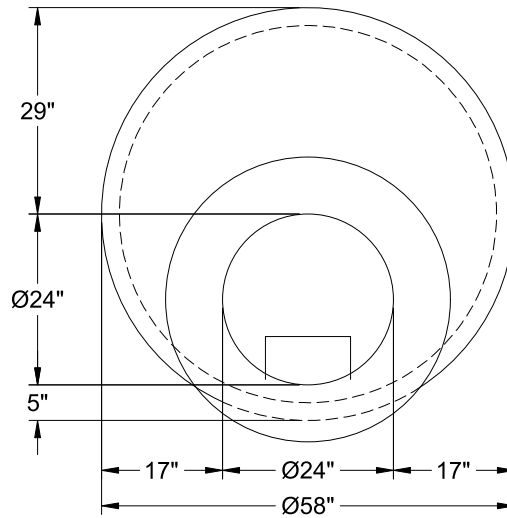

48" - ECC CONE w/ 24" HOLE F/G - 36" - (P2)

Coating (Int):
 Coating (Ext):

Seam Up: Flat
 Seam Dn: Groove

Wall Thickness: 5"

Height (Ext): 36"

Weight (Net): 3000 lb
 Volume (Net): 0.5cu.yd