

TOP VIEW

GENERAL NOTES

1. CONCRETE 28 DAY COMPRESSIVE STRENGTH OF 5000 PSI.
2. REINFORCING PER ASTM A-615:
TOP SLAB: #4 BAR @ 8" C.C.E.W. DBL MAT
BASE #4 @ 8" C.C.E.W
3. VAULT JOINT TO BE SEALED WITH CONSEAL CS-102 ROLL (SUPPLIED BY ICAST).
4. WEIGHT:
TOP SLAB = 5,396 LBS
BASE SECTION = 14,258 LBS
TOTAL = 19,654 LBS

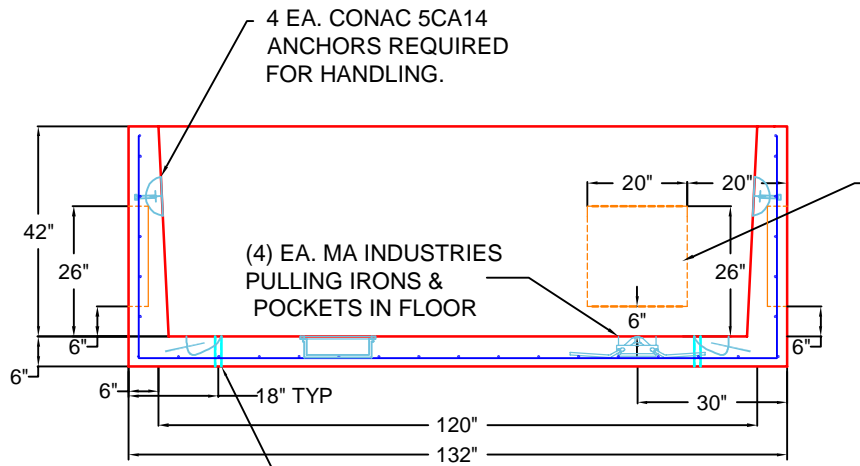

FRONT VIEW

4. EA 20"X20"X4" THICK KNOCK OUT PANEL NEAR AND FAR WALL

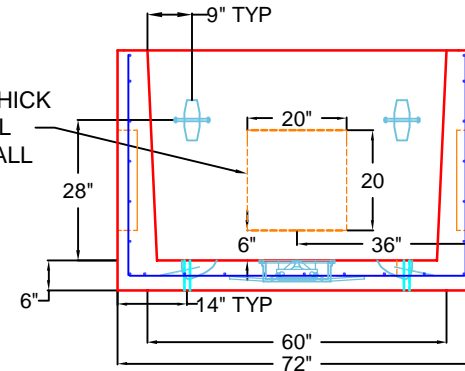

SIDE VIEW

(4) EA 1" PVC CAST IN FLOOR FOR GROUNDING RODS

RIGHT-SIDE UP VIEW

RIGHT-SIDE UP VIEW

REVISION INFORMATION

REV. DATE: NO REVISIONS TO DATE



PRODUCTION DRAWING: 5'X10' SWITCH GEAR PIT BASE

CUSTOMER: KEMPER CONSTRUCTION

PROJECT: CVG 200 MLLC

STRUCTURE: PIT 5

QUOTE/SALES ORDER NO: 25-2930

CHK BY: B SMITH

DRAWN BY: C. RUSS

DATE: 08/12/25

SCALE: NTS

PG. 1 of 1