

**GENERAL NOTES :**

1. CONCRETE 28 DAY COMPRESSIVE STRENGTH OF 5000 PSI.
2. REINFORCING PER ASTM A-615:  
TOP SLAB: #4 BAR @ 8" C.C.E.W. DBL MAT  
BASE #4 @ 8" C.C.E.W
3. VAULT JOINT TO BE SEALED WITH CONSEAL CS-102 ROLL (SUPPLIED BY ICAST).
4. WEIGHT:  
TOP SLAB = 5,396 LBS  
BASE SECTION = 14,258 LBS  
TOTAL = 19,654 LBS
5. TOP COVER PLATE PROVIDED BY OTHERS
6. (2)108" LONG UNISTRUT SECTIONS FOR  $\frac{1}{2}$ " INSERTS CAST INTO TOP SLAB (ATKORE UNISTRUT P3254WC PG)

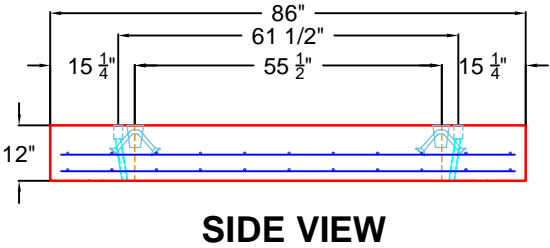
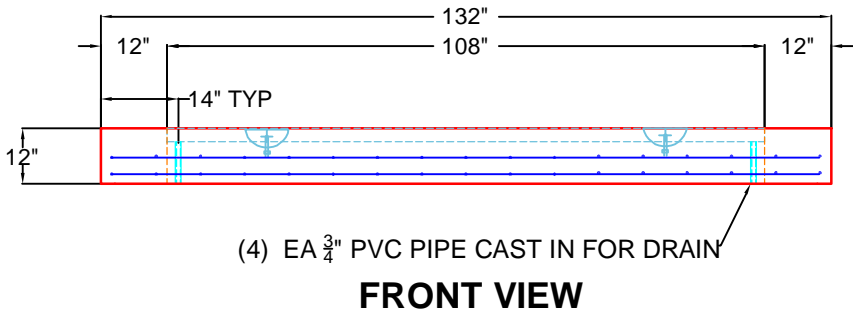
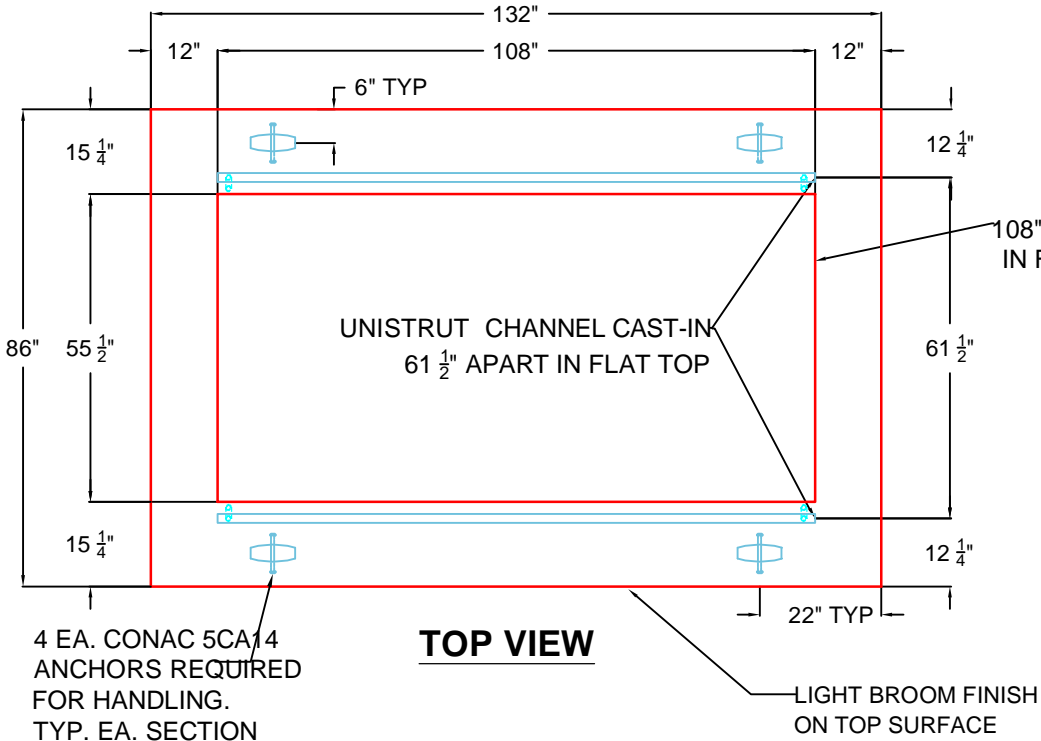

REVISION INFORMATION

REV.  $\Delta$  DATE: NO REVISIONS TO DATE



PRODUCTION DRAWING: 5'X10' SWITCH GEAR PIT TOP		
CUSTOMER: KEMPER CONSTRUCTION		
PROJECT: CVG 200 MLLC		
STRUCTURE: PIT 4		
QUOTE/SALES ORDER NO: 25-2930		
CHK BY: B SMITH	DRAWN BY: C. RUSS	
DATE: 08/12/25	SCALE: NTS	PG. 1 of 1