

Job Name: 25-2898B - Hunter's Ridge Ph.1
 Job Location: Owensboro, KY
 Contractor: Ernie Davis & Sons Mechanical, Inc.

Plant: 100
 12/16/2025 1:57:31 PM

Tech: J. Horsley - F
 PC: T. Lewis



Structure ID: MH A-8

P4 GR4CDARED

GRADE RING w/ConBlock-CDA Red F/F

- P5) 24" - CASTING HEIGHT - 7"
- P4) 24" - GRADE RING w/ConBlock-CDA Red F/F - 4"
- P3) 48" - ECC CONE w/ 24" HOLE, w/ConBlock-CDA Red F/G - 36"
- P2) 48" - MH RISER w/ConBlock-CDA Red T/G - 60"
- P1) 48" - MH BASE w/ConBlock-CDA Red T/n - 30"
- 1) JOINT WRAP - 0.065"x6"x50' CONSEAL CS212
- 1) JOINT WRAP PRIMER - CONSEAL CS-75 (1 gal.)
- 1) ADMIXTURE CONBLOCK CDA RED
- 1) 48" - MH INVERT CHANNEL w/ConBlock-CDA Red - FULL HEIGHT
- 2) 48" - Conseal CS-102 1.00" (Double)
- 3) PSX - 12-08 NYLO
- 10) MH Step ML-10-TDS-NCR - 10"

0 lb
 270 lb
 2251 lb
 4192 lb
 3282 lb
 0 lb
 0 lb
 0 lb
 0 lb
 1440 lb
 0 lb
 24 lb
 0 lb

 Structure Total: 11459 lb

- Structure Notes:**
1. PER ASTM C-478 SPECIFICATIONS
 2. CONCRETE: 4,000 PSI AT 28 DAYS
 3. REINFORCEMENT: (1) #3 HOOP CENTERED (GRADE 60)
 4. CONBLOCK CDA RED ADMIXTURE REQUIRED

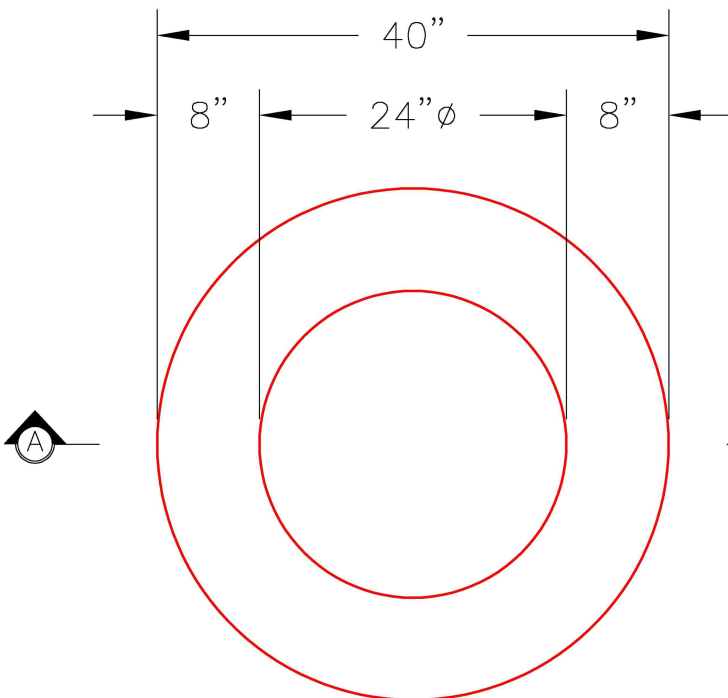

PLAN VIEW

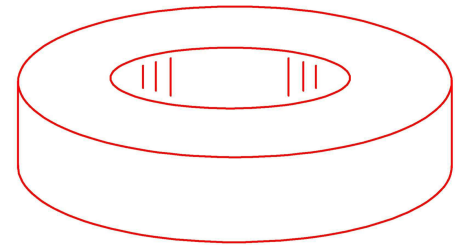

ISOMETRIC VIEW

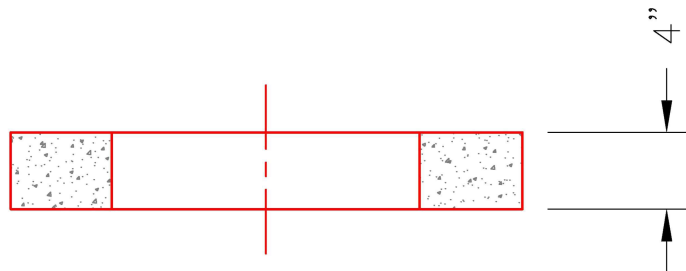

SECTION A-A

Coating (Int):
 Coating (Ext):

Seam Up: Flat
 Seam Dn: Flat

Wall Thickness: 8"

Height (Ext): 4"

Weight (Net): 270 lb
 Volume (Net): 0.07cu.yd