

Structure ID: CB9

P1 BX2436-08BVF

BOX BASE 8inW, 8inF, Variable Ht F/n

P2) 24" x 36" - CASTING HEIGHT - 6" P1) 24" x 36" - BOX BASE 8inW, 8inF, Variable Ht F/n - 26" 1) 24" x 36" - SGL 1"x14.5' Butyl 1) Hole - 20 1) Hole - 16	0 lb 3703 lb 0 lb 0 lb 0 lb ----- Structure Total: 3703 lb
--	--

Structure Notes:

1. JR HOE HOE-525-LV PROVIDED BY ICAST.
2. PER ASTM C913 SPECIFICATIONS.
3. CONCRETE = 4,000 PSI AT 28 DAYS.
4. REINFORCING PER ASTM A615 (GRADE 60).
 - WALLS (As .12) #5 BARS AT 12" C.C.E.W.
 - FLOOR (As .12) #5 BARS AT 12" C.C.E.W.

Rim: 357.4' Rim to Invert: 2.73' Slack: 0.76" Sump: 0" Step Position:

Position	Elev	Angle	Ext. (cw)	Pipe	Pipe OD	Connector	Hole	Horz Size	Up ()	Offset
Invert 1	354.67'	0°	20"	15" HDPE	17.6"	Hole 20	20"	20"	-1.25"	0"
Invert 2	354.92'	180°	20"	12" HDPE	14.5"	Hole 16	16"	16"	1.75"	0"
Invert 3										
Invert 4										
Invert 5										
Invert 6										
Invert 7										
Invert 8										

RIGHT-SIDE UP VIEW (int. dimensions)

UPSIDE-DOWN VIEW (int. dimensions)

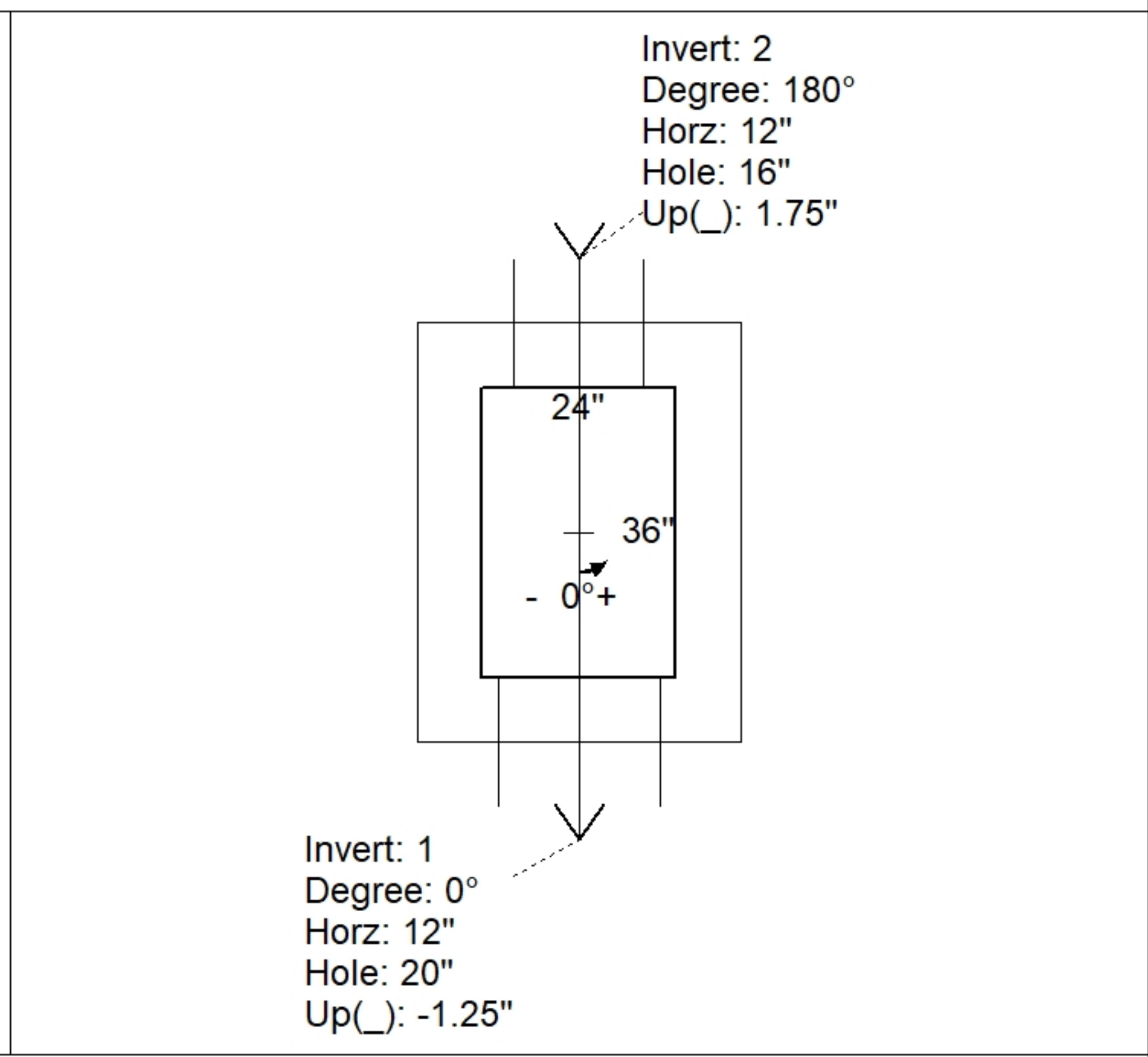
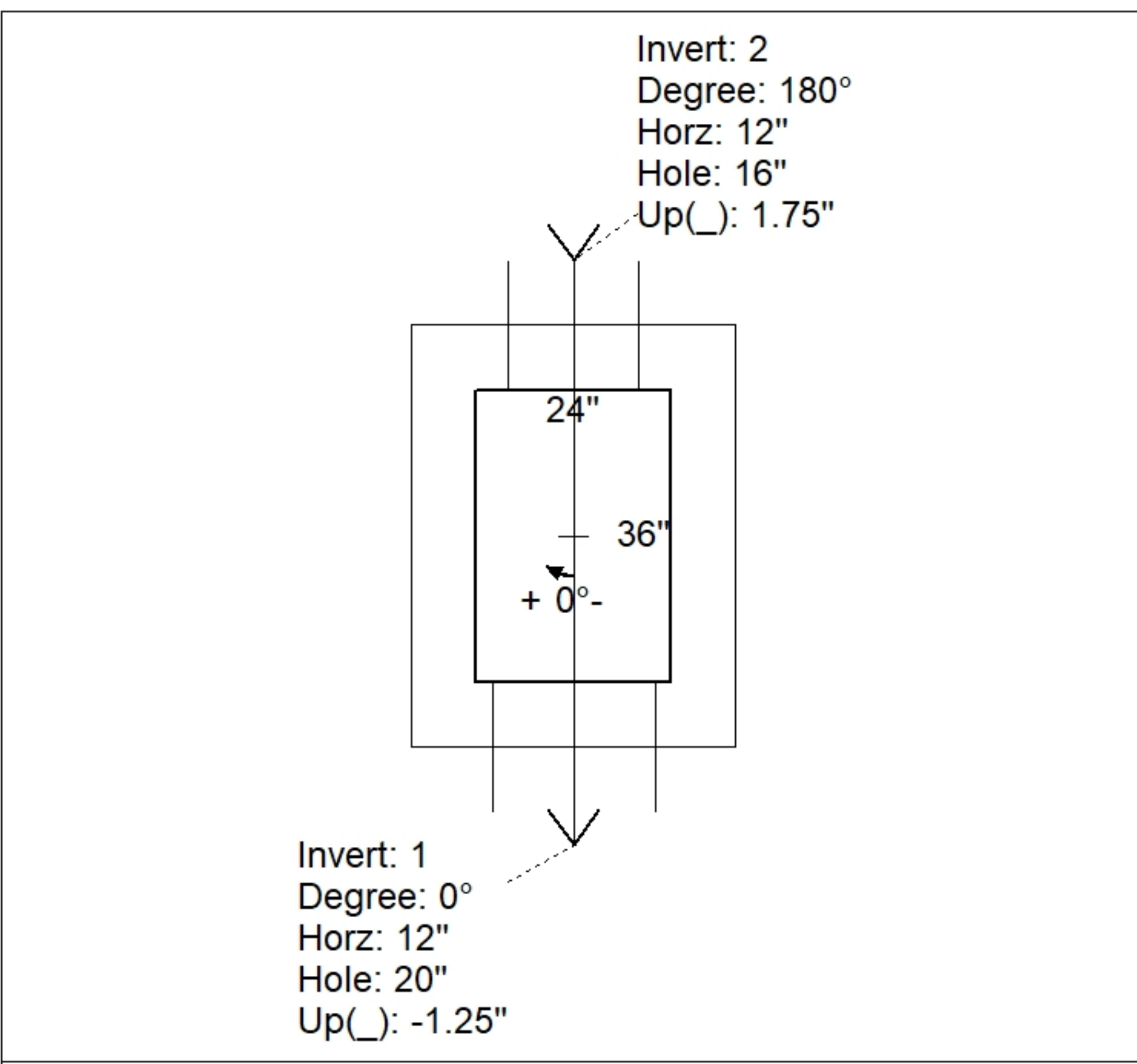
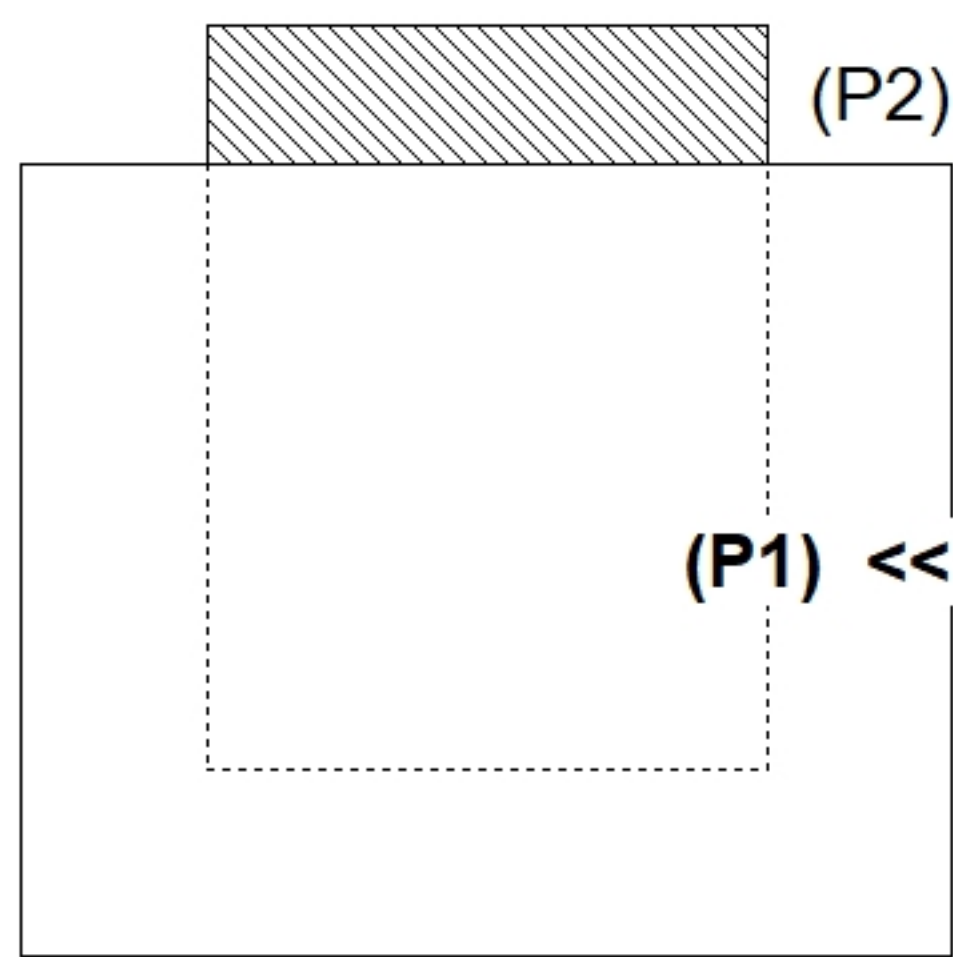

INSIDE WALL DIMENSIONS

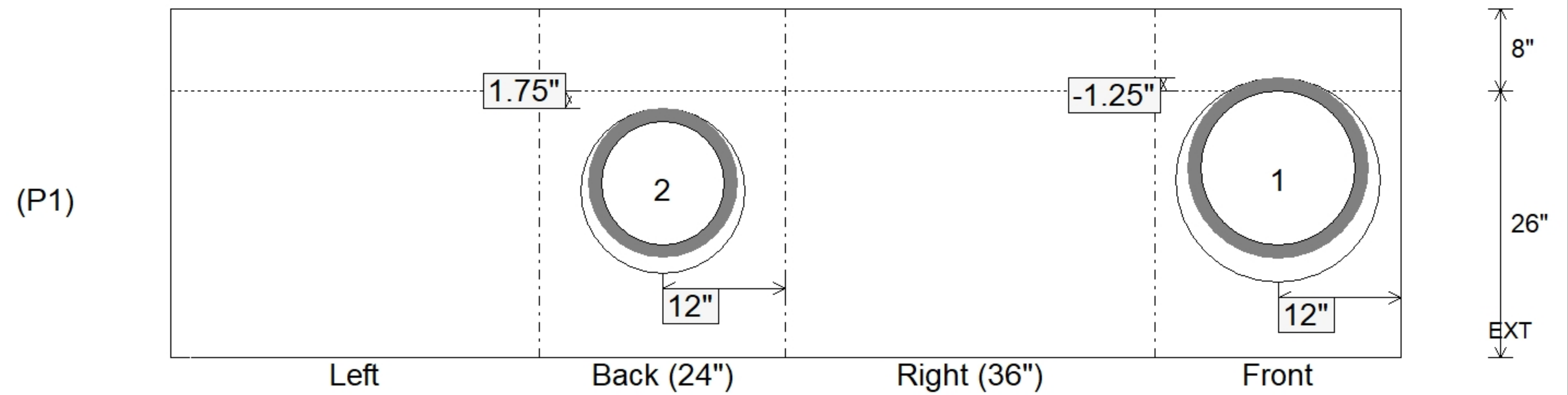

Coating (Int): Coating (Ext):	Seam Up: Flat Seam Dn: n/a	Wall Thickness: 8" Floor Height: 8"	Height (Int): 26" Height (Ext): 34"	Weight (Net): 3703 lb Volume (Net): 0.95cu.yd
----------------------------------	-------------------------------	--	--	--