

Job Name: 25-2644B Limestone Edge Apartments
Job Location: Bedford, IN
Contractor: S&J Excavation

PC: J. Jarvis
 TECH: J. Coppage
 Plant: Beaver Dam



Structure ID: **STR-35**
 Spec: INDOT
 Type: INLET TYPE A
 Size: 24" x 24"

Rim: 642.4'
 Invert: 638.83'
 Rim to Invert: 3.57'

Sump: 0"
 Floor (Top): 638.83'
 Floor Height: 8"

Floor (Bot): 638.163'
 Overall Height: 4.167'
 Slack: 0.84"

Structure Notes:

1. EJ-6500 GRATE PROVIDED BY ICAST.
2. INDOT INLET TYPE A / ASTM C913 SPEC'S.
3. CONCRETE = 4,000 PSI AT 28 DAYS.
4. REINFORCING PER ASTM A615 (GRADE 60).
 - WALLS (As .31) #5 BARS AT 12" C.C.E.W.
 - FLOOR (As .31) #5 BARS AT 12" C.C.E.W.

STRUCTURE SUMMARY:

P2) 24" x 24" - CASTING HEIGHT - 1"	0 lb
P1) 24" x 24" - BOX BASE 8inW, 8inF, Variable Ht - 41"	4173 lb
1) CASTING - EJ 6500 GRT	250 lb
1) 24" x 24" - Conseal CS-102 1.00"	0 lb
2) Hole - 18	0 lb
1) Hole - 10	0 lb
Structure Total:	4423 lb

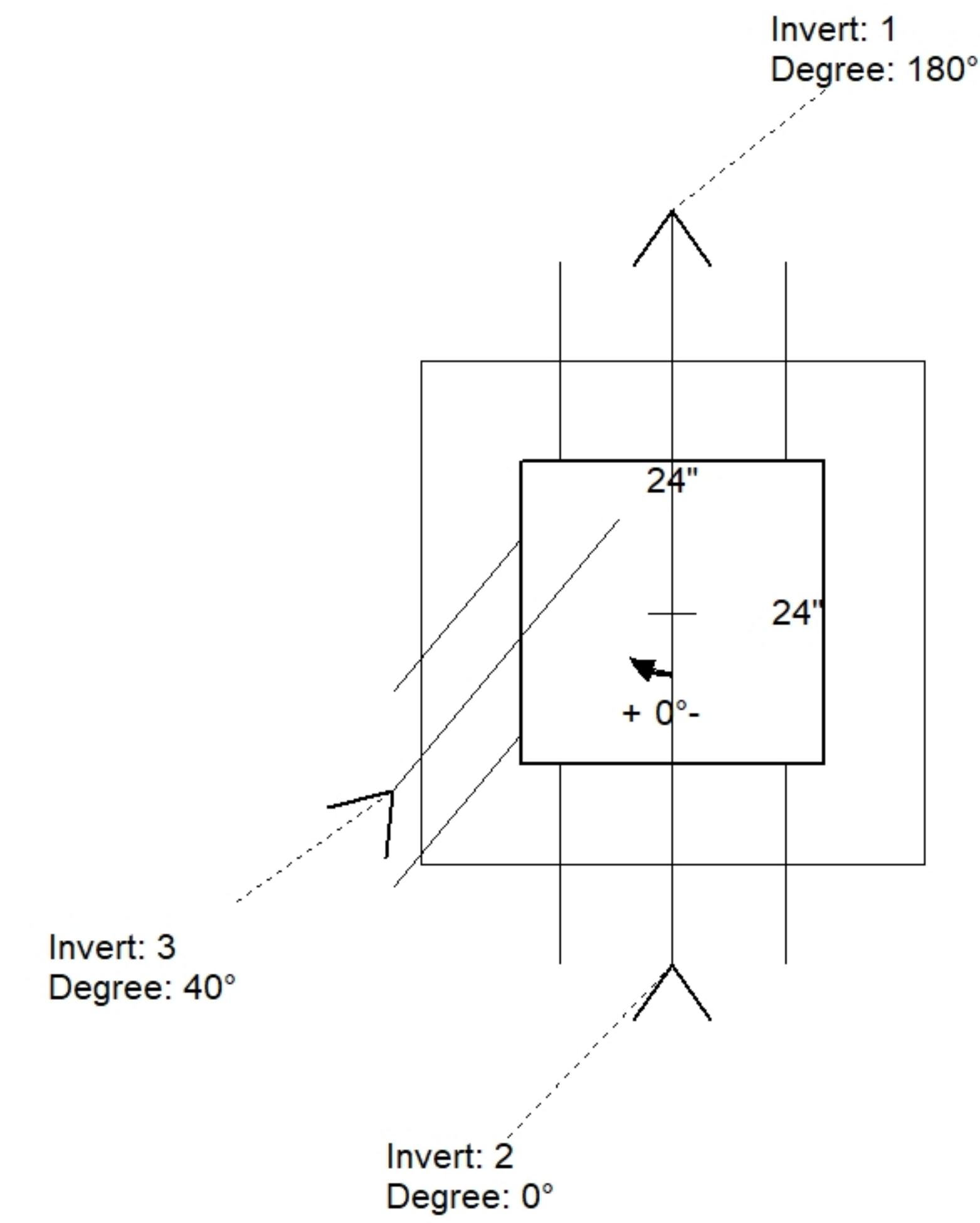

Position	Elev	Angle	Pipe	Pipe OD	Hole	Connector	Up ()	Ref
Rim	642.4'							
Reducer								
Invert 1	638.83'	180°	12" HDPE	14.5"	18"	Hole 18	-1.25"	P1
Invert 2	638.83'	0°	12" HDPE	14.5"	18"	Hole 18	-1.25"	P1
Invert 3	639.9'	40°	6" HDPE	6.9"	10"	Hole 10	12.39"	P1
Invert 4								
Invert 5								
Invert 6								
Invert 7								
Invert 8								

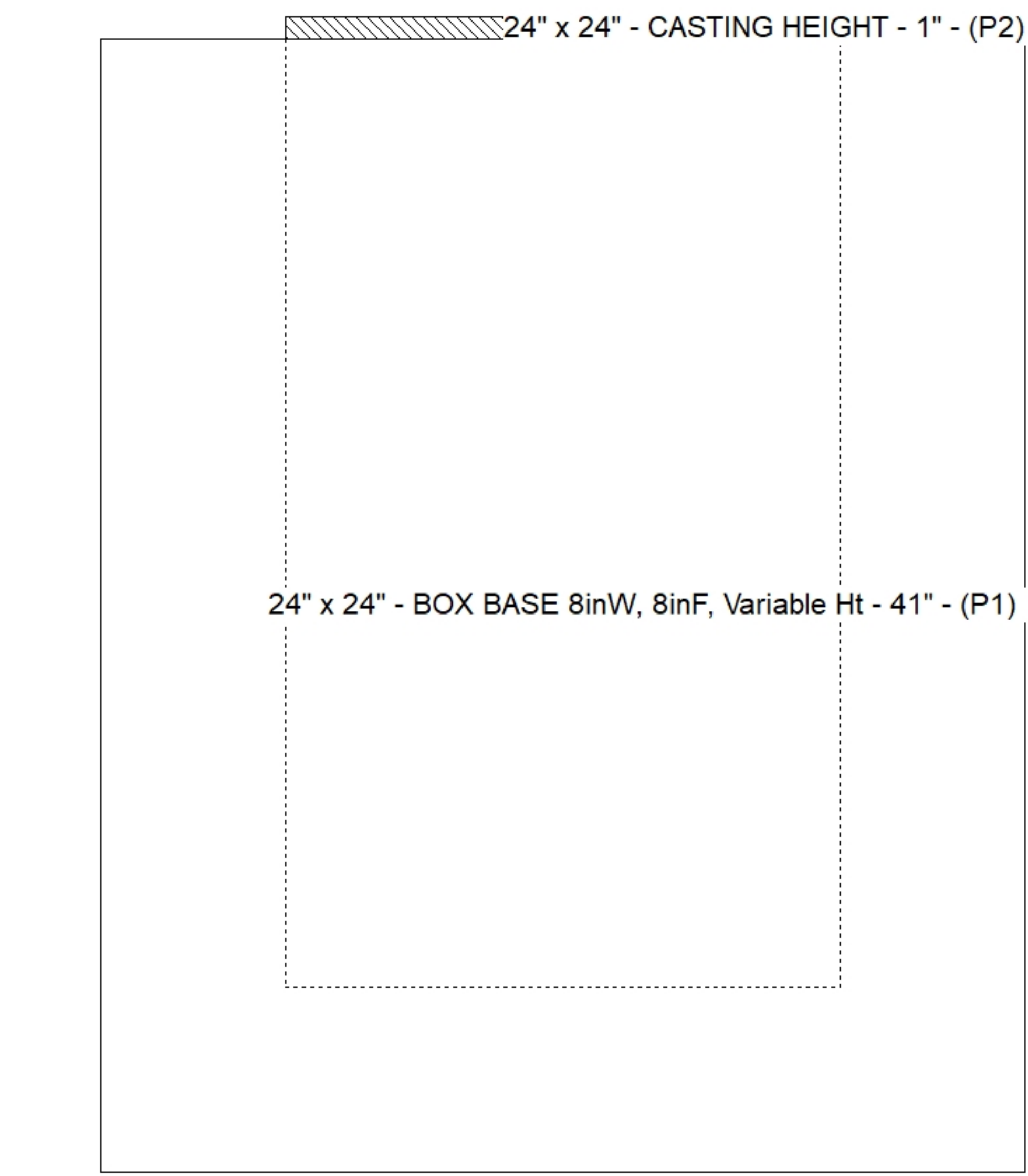

Default - Interior Dimensions

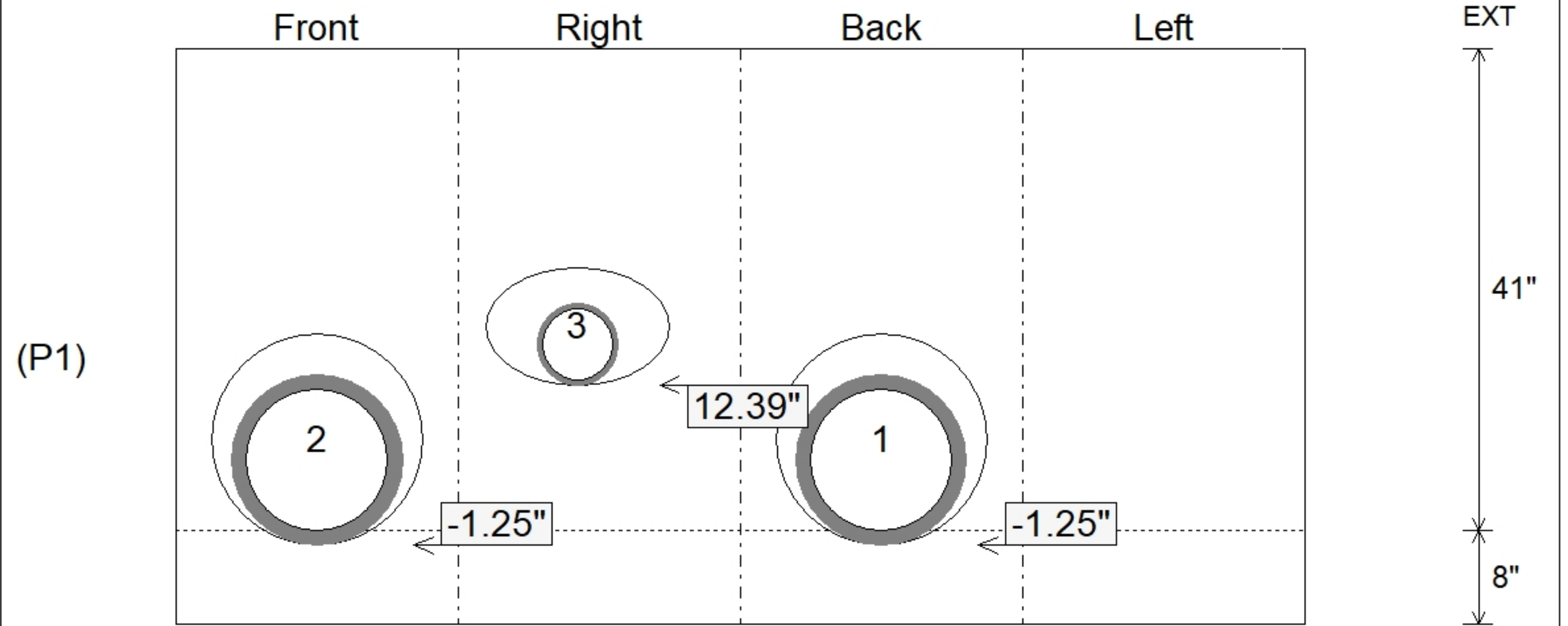

Submittal Drawing
 10/28/2025 2:30:33 PM

SUBMITTAL
 APPROVED BY: