

**Job Name: 25-2644B Limestone Edge Apartments**  
**Job Location: Bedford, IN**  
**Contractor: S&J Excavation**

PC: J. Jarvis  
 TECH: J. Coppage  
 Plant: Beaver Dam



Structure ID: **STR-15**  
 Spec: INDOT  
 Type: INLET TYPE A  
 Size: 24" x 24"

Rim: 641.9'  
 Invert: 639.23'  
 Rim to Invert: 2.67'

Sump: 0"  
 Floor (Top): 639.23'  
 Floor Height: 8"

Floor (Bot): 638.563'  
 Overall Height: 3.333'  
 Slack: 0.04"

**Structure Notes:**

1. EJ-6500 GRATE PROVIDED BY ICAST.
2. INDOT INLET TYPE A / ASTM C913 SPEC'S.
3. CONCRETE = 4,000 PSI AT 28 DAYS.
4. REINFORCING PER ASTM A615 (GRADE 60).  
 - WALLS (As .31) #5 BARS AT 12" C.C.E.W.  
 - FLOOR (As .31) #5 BARS AT 12" C.C.E.W.

**STRUCTURE SUMMARY:**

P2) 24" x 24" - CASTING HEIGHT - 1"	0 lb
P1) 24" x 24" - BOX BASE 8inW, 8inF, Variable Ht - 31"	3343 lb
1) CASTING - EJ 6500 GRT	250 lb
1) 24" x 24" - Conseal CS-102 1.00"	0 lb
2) Hole - 18	0 lb
1) Hole - 10	0 lb
<b>Structure Total:</b>	<b>3593 lb</b>

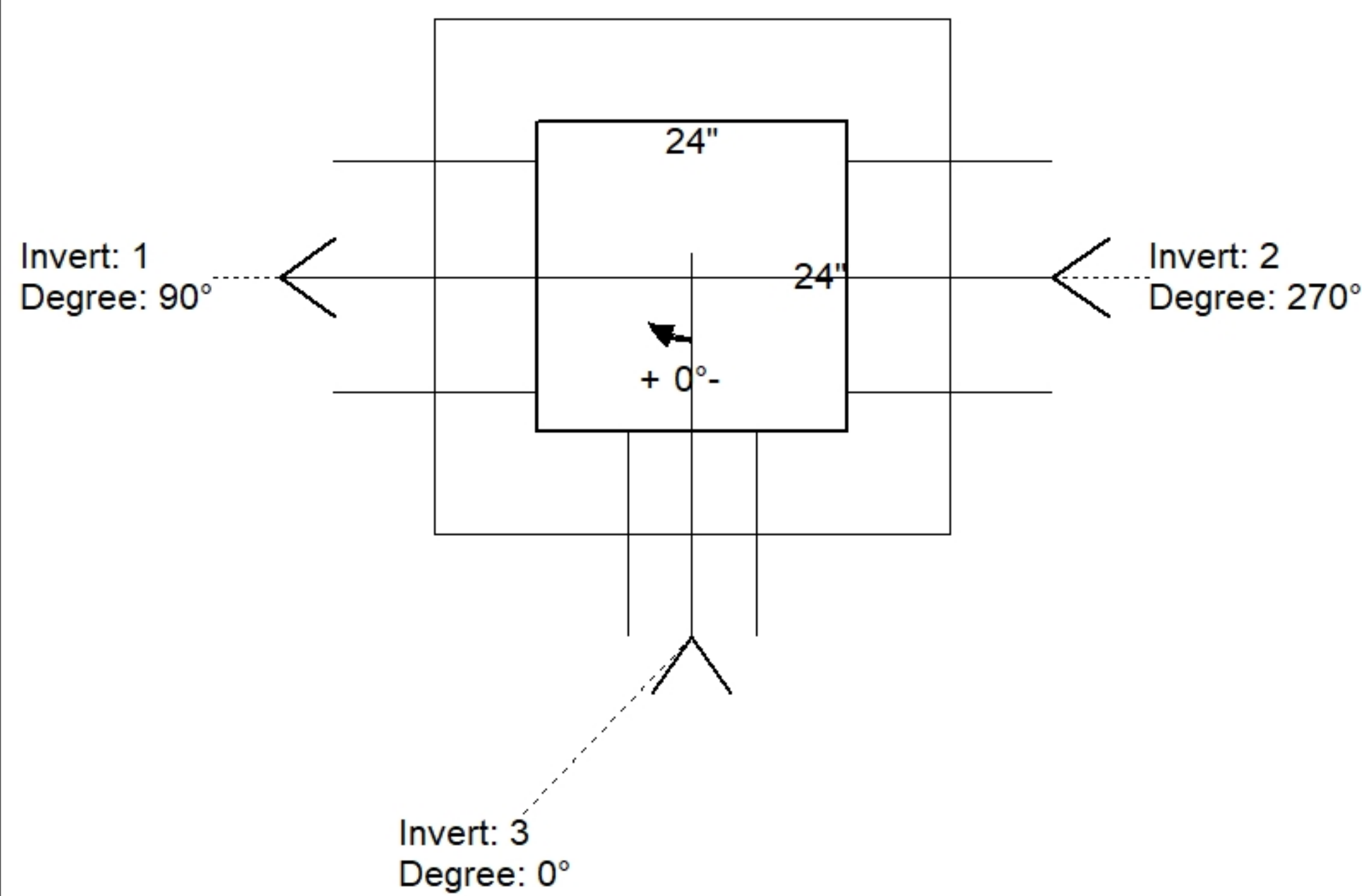

Position	Elev	Angle	Pipe	Pipe OD	Hole	Connector	Up ( )	Ref
Rim	641.9'							
Reducer								
Invert 1	639.23'	90°	12" HDPE	14.5"	18"	Hole 18	-1.25"	P1
Invert 2	639.23'	270°	12" HDPE	14.5"	18"	Hole 18	-1.25"	P1
Invert 3	639.34'	0°	6" HDPE	6.9"	10"	Hole 10	0.87"	P1
Invert 4								
Invert 5								
Invert 6								
Invert 7								
Invert 8								

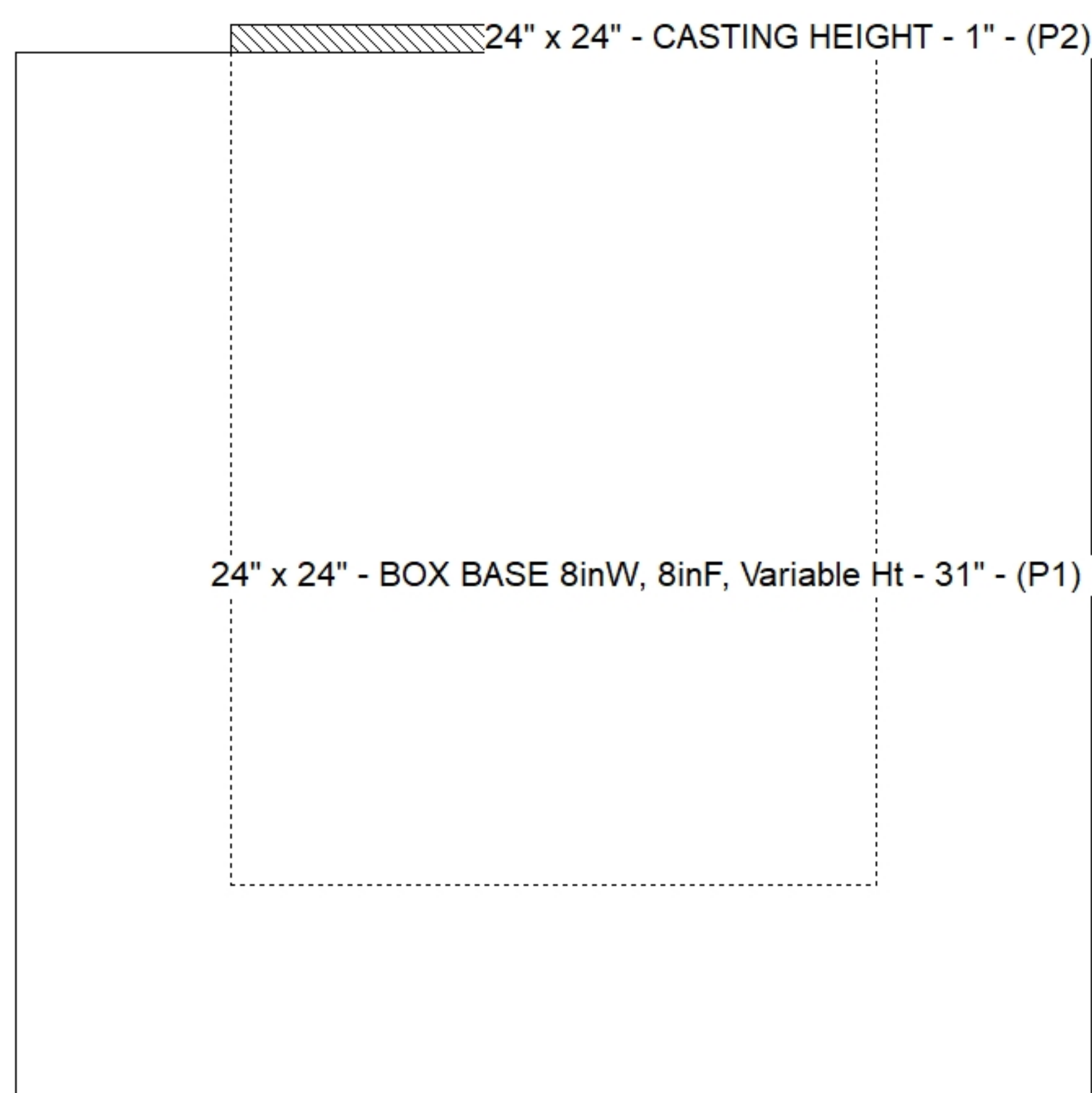

**Default - Interior Dimensions**

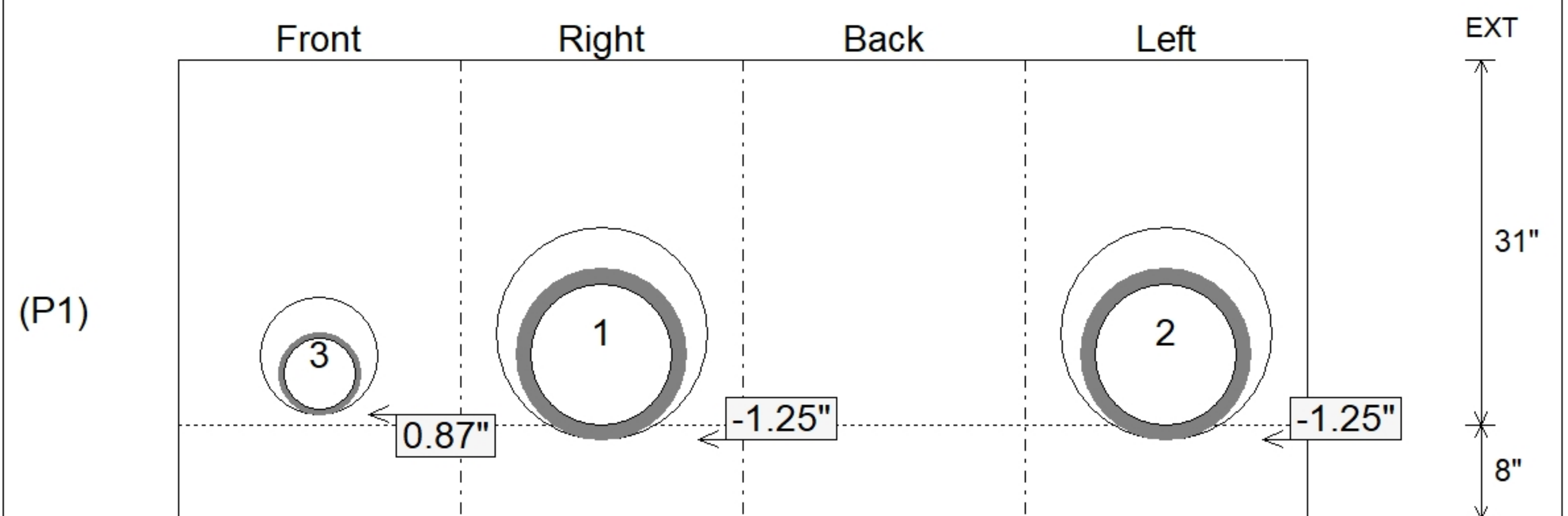

Submittal Drawing  
 10/28/2025 2:30:29 PM

SUBMITTAL  
 APPROVED BY: