

Job Name: 25-2592 - Meadows-Northland Ph 7
 Job Location: Lexington, KY
 Contractor: Delmae LLC

Plant: 100

2/5/2026 2:17:59 PM

Tech: J. Horsley - F

PC: T. Lewis



Structure ID: 230

P2 MH048CN30CDARED

ECC CONE w/ 24" HOLE, w/ConBlock-CDA Red F/G

- P4) 24" - CASTING HEIGHT - 7"
- P3) 24" - GRADE RING w/ConBlock-CDA Red F/F - 4"
- P2) 48" - ECC CONE w/ 24" HOLE, w/ConBlock-CDA Red F/G - 30"
- P1) 48" - MH BASE w/FLANGE (08F/08EF) w/ConBlock-CDA Red T/n - 24"
- 1) 48" - MH INVERT CHANNEL w/ConBlock-CDA Red - FULL HEIGHT
- 1) JOINT WRAP - 12" WD x 048" MAC WRAP
- 1) ADMIXTURE CONBLOCK CDA RED
- 1) 48" - Conseal CS-102 1.00" (Double)
- 2) PSX - 12-08 NYLO
- 5) MH Step ML-10-TDS-NCR - 10"

0 lb
 270 lb
 1961 lb
 4468 lb
 1440 lb
 0 lb
 0 lb
 0 lb
 16 lb
 0 lb

Structure Notes:

1. PER ASTM C-478 SPECIFICATIONS
2. CONCRETE: 4,000 PSI AT 28 DAYS
3. REINFORCEMENT: PER ASTM A615
4. CONBLOCK CDA RED ADMIXTURE REQUIRED
5. STEPS REQUIRED
6. HOE MC-350 FRAME & COVER "SANITARY" SUPPLIED BY OTHERS

Structure Total: 8155 lb

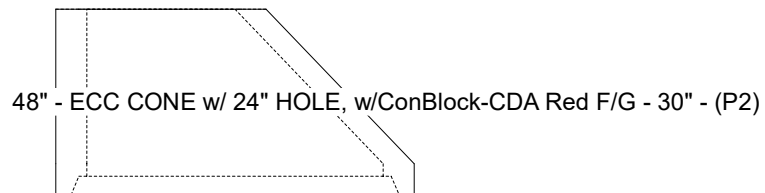
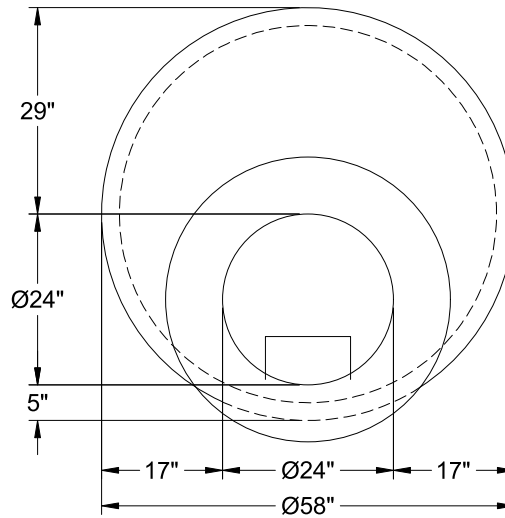

48" - ECC CONE w/ 24" HOLE, w/ConBlock-CDA Red F/G - 30" - (P2)

Coating (Int):
 Coating (Ext):

Seam Up: Flat
 Seam Dn: Groove

Wall Thickness: 5"

Height (Ext): 30"

Weight (Net): 1961 lb
 Volume (Net): 0.5cu.yd