

Job Name: 25-2113B WCHS Ph 3 Athletics Project
 Job Location: Springfield, KY
 Contractor: Caliber Construction Inc.

Plant: 100

Tech: J. Horsley - A

1/7/2026 11:01:55 AM

PC: Jay Jarvis



Structure ID: 2

P1 MH048BA24

MH BASE T/n

P3) 24" - CASTING HEIGHT - 7"	0 lb
P2) 48" - ECC CONE w/ 24" HOLE F/G - 36"	3000 lb
P1) 48" - MH BASE T/n - 24"	2863 lb
1) JOINT WRAP - 0.065"x6"x50" CONSEAL CS212	0 lb
1) JOINT WRAP PRIMER - CONSEAL CS-75 (1 gal.)	0 lb
1) 48" - MH INVERT CHANNEL - FULL HEIGHT	1440 lb
1) CASTING - HOE MC-315 F/C Sanitary	258 lb
1) 48" - Conseal CS-102 1.00" (Double)	0 lb
3) PSX - 12-06 NYLO	24 lb
4) MH Step ML-10-TDS-NCR - 10"	0 lb
Structure Total:	7585 lb

Structure Notes:
 1. HOE MC-315 FRAME & COVER "SANITARY" PROVIDED BY ICAST
 2. PER ASTM C-478 SPECIFICATIONS
 3. CONCRETE: 4,000 PSI AT 28 DAYS
 4. REINFORCEMENT: PER ASTM A615
 5. INVERT CHANNEL REQUIRED
 6. STEPS AT 0 DEGREES

Rim: 791' Rim to Invert: 5.5' Slack: 2" Sump: 3" Step Position: 0°

Position	Elev	Angle	Ext. (cw)	Pipe	Pipe OD	Connector	Hole	Horz Size	Up ()	Offset
Invert 1	785.5'	0°	0"	6" PVC SDR35	6.25"	PSX 12-06 NYLO	12"	12.129"	0"	0"
Invert 2	785.6'	113°	57.194"	6" PVC SDR35	6.25"	PSX 12-06 NYLO	12"	12.129"	1.2"	0"
Invert 3	785.6'	164°	83.008"	6" PVC SDR35	6.25"	PSX 12-06 NYLO	12"	12.129"	1.2"	0"
Invert 4										
Invert 5										
Invert 6										
Invert 7										
Invert 8										

RIGHT-SIDE UP VIEW (int. dimensions)

UPSIDE-DOWN VIEW (int. dimensions)

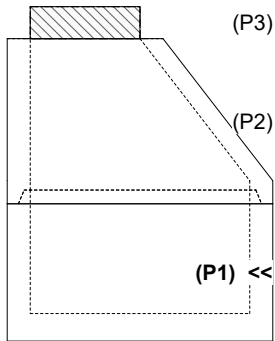
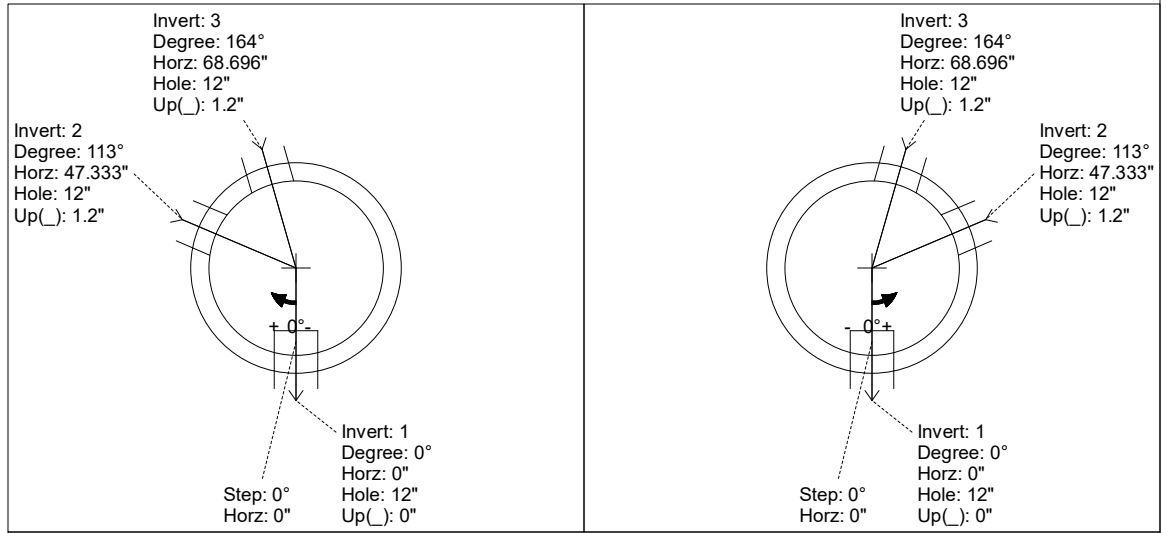

INSIDE WALL DIMENSIONS

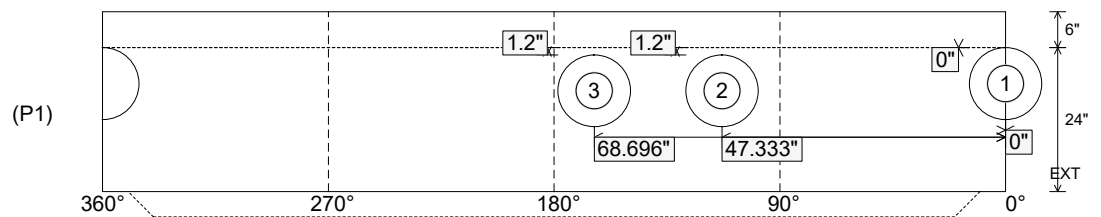

Coating (Int):
 Coating (Ext):

Seam Up: Tongue
 Seam Dn: n/a

Wall Thickness: 5"
 Floor Height: 6"

Height (Int): 24"
 Height (Ext): 30"

Weight (Net): 2863 lb
 Volume (Net): 0.73cu.yd

Structure ID: 2

P1 MH048BA24

MH BASE T/n

P3) 24" - CASTING HEIGHT - 7" P2) 48" - ECC CONE w/ 24" HOLE F/G - 36" P1) 48" - MH BASE T/n - 24" 1) JOINT WRAP - 0.065"x6"x50" CONSEAL CS212 1) JOINT WRAP PRIMER - CONSEAL CS-75 (1 gal.) 1) 48" - MH INVERT CHANNEL - FULL HEIGHT 1) CASTING - HOE MC-315 F/C Sanitary 1) 48" - Conseal CS-102 1.00" (Double) 3) PSX - 12-06 NYLO 4) MH Step ML-10-TDS-NCR - 10"	0 lb 3000 lb 2863 lb 0 lb 0 lb 1440 lb 258 lb 0 lb 24 lb 0 lb ----- Structure Total: 7585 lb	Structure Notes: 1. HOE MC-315 FRAME & COVER "SANITARY" PROVIDED BY ICAST 2. PER ASTM C-478 SPECIFICATIONS 3. CONCRETE: 4,000 PSI AT 28 DAYS 4. REINFORCEMENT: PER ASTM A615 5. INVERT CHANNEL REQUIRED 6. STEPS AT 0 DEGREES
---	---	--

Rim: 791' Rim to Invert: 5.5' Slack: 2" Sump: 3" Step Position: 0°

Position	Elev	Angle	Ext. (cw)	Pipe	Pipe OD	Connector	Hole	Horz Size	Up ()	Offset
Invert 1	785.5'	0°	0"	6" PVC SDR35	6.25"	PSX 12-06 NYLO	12"	12.129"	0"	0"
Invert 2	785.6'	113°	57.194"	6" PVC SDR35	6.25"	PSX 12-06 NYLO	12"	12.129"	1.2"	0"
Invert 3	785.6'	164°	83.008"	6" PVC SDR35	6.25"	PSX 12-06 NYLO	12"	12.129"	1.2"	0"
Invert 4										
Invert 5										
Invert 6										
Invert 7										
Invert 8										

RIGHT-SIDE UP VIEW (int. dimensions)

UPSIDE-DOWN VIEW (int. dimenions)

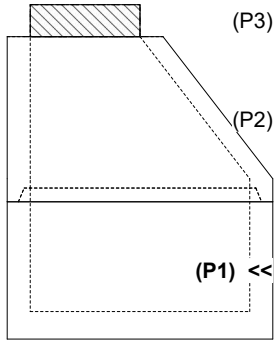
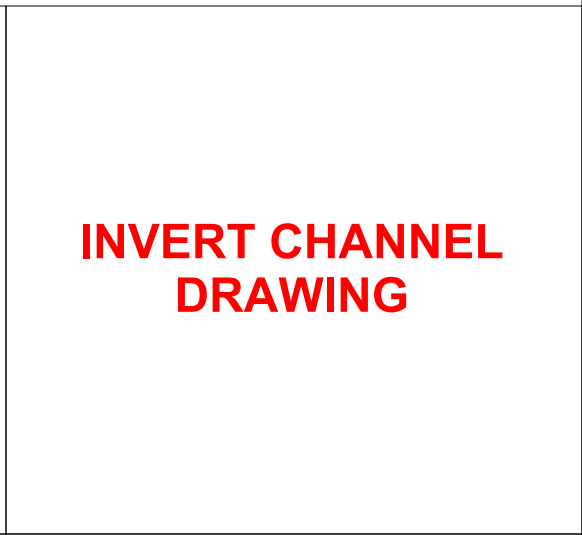
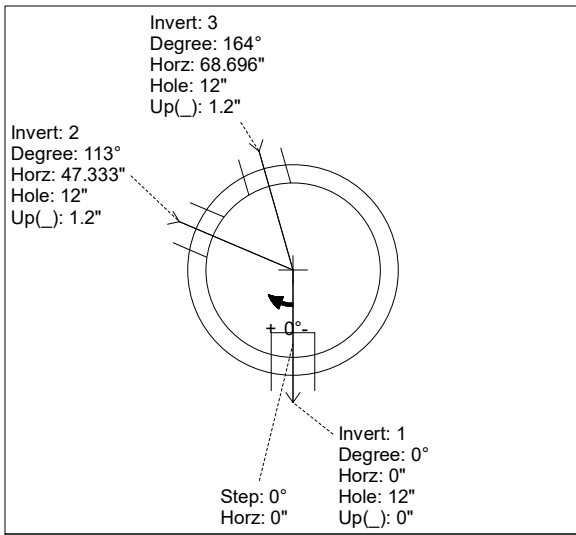

INSIDE WALL DIMENSIONS

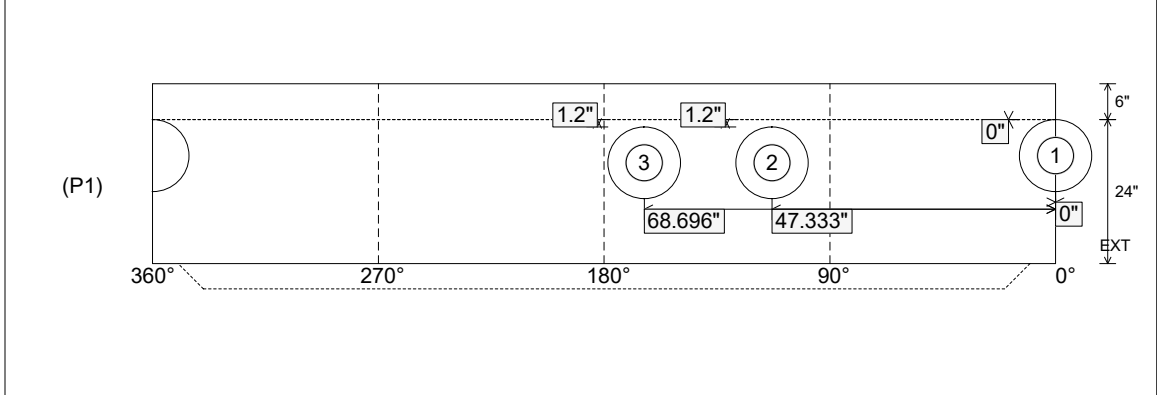

Coating (Int): Coating (Ext):	Seam Up: Tongue Seam Dn: n/a	Wall Thickness: 5" Floor Height: 6"	Height (Int): 24" Height (Ext): 30"	Weight (Net): 2863 lb Volume (Net): 0.73cu.yd
----------------------------------	---------------------------------	--	--	--