

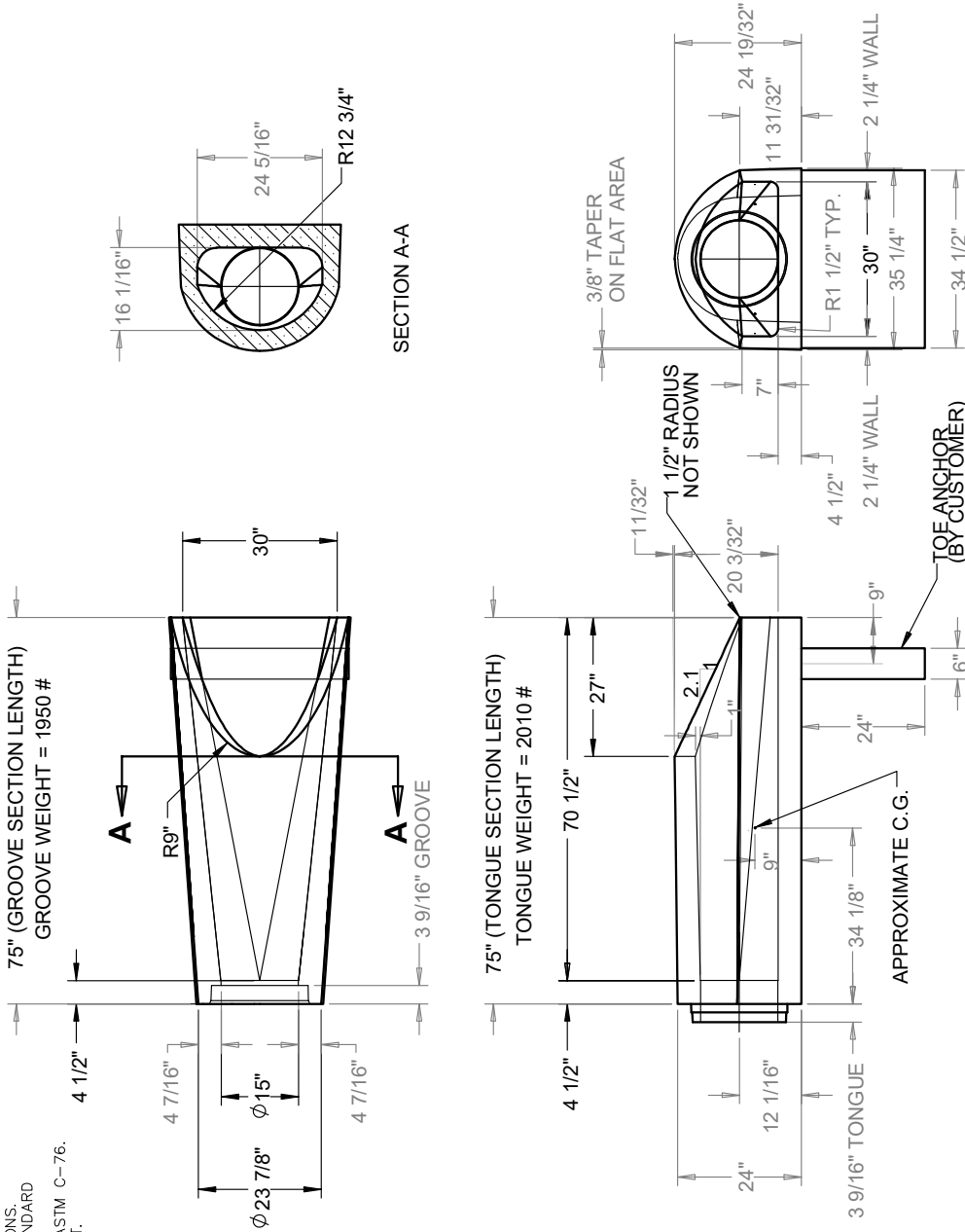

Structure ID: FES-4

P1 FES15B

15" - RCP FLARED END SECTION BELL (OUTLET)



GENERAL NOTES:

1. FLARED END SECTION IS MANUFACTURED AND TESTED IN ACCORDANCE WITH ASTM C-76 OR ASTM C-655 AND AASHTO M-170 SPECIFICATIONS.
2. ALL PIPE JOINTS MEET ASTM C-443 AND C-361 SPECIFICATIONS.
3. INSTALL REINFORCED CONCRETE PIPE PER ASTM C-1479--STANDARD PRACTICE FOR INSTALLATION OF PRECAST CONCRETE PIPE.
4. FLARED END SECTION REINFORCING IS IN ACCORDANCE WITH ASTM C-76.
5. WEIGHT SHOWN IS CALCULATED USING 150 LBS. PER CUBIC FT. UNIT WEIGHT OF CONCRETE.

ISOMETRIC VIEW

