

Job Name: 25-1922 - Reynold's Farm
 Job Location: Goodlettsville, TN 37072
 Contractor: Josh King Excavation

Plant: Beaver Dam, KY
 1/8/2026 9:01:34 AM

Tech: K. Cardwell
 PC: J. Jarvis



Structure ID: C5

P2 MH060LD08-28SQ

MH FLAT TOP w/28"x28" Hole F/F

- P3) 28" x 28" - CASTING HEIGHT - 7.50"
- P2) 60" - MH FLAT TOP w/28"x28" Hole F/F - 8"
- P1) 60" - MH BASE Custom Ht F/n - 32"
- 1) CASTING - JBS 3300 SET (F/G/H)
- 1) 60" - Conseal CS-102 1.00"
- 1) 28" x 28" - Conseal CS-102 1.00"
- 1) DOGHOUSE INVRTD - 32"x32"
- 1) DOGHOUSE INVRTD - 32"x30"

0 lb
 2217 lb
 5340 lb
 500 lb
 0 lb
 0 lb
 0 lb
 0 lb

 8057 lb

Structure Total:

- Structure Notes:
1. PER ASTM C-478 SPECS
 2. CONCRETE: 4,000 PSI AT 28 DAYS
 3. REINFORCEMENT: #5 BAR @ 6" C.C. E.W. (GRADE 60) - 2" MIN. REBAR CLEARANCE (TYP)
 4. NO STEPS
 5. JBS 3300 FRAME, GRATE, & CURB HOOD SUPPLIED BY ICAST
 6. LIFTERS: 4 EA. WRA016 CONAC WIRE ROPE ANCHORS FOR PLANT & FIELD HANDLING

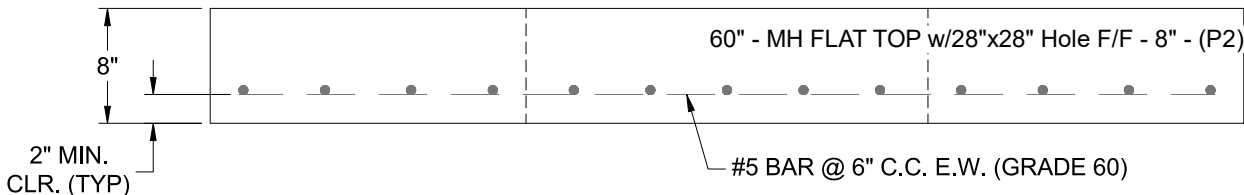
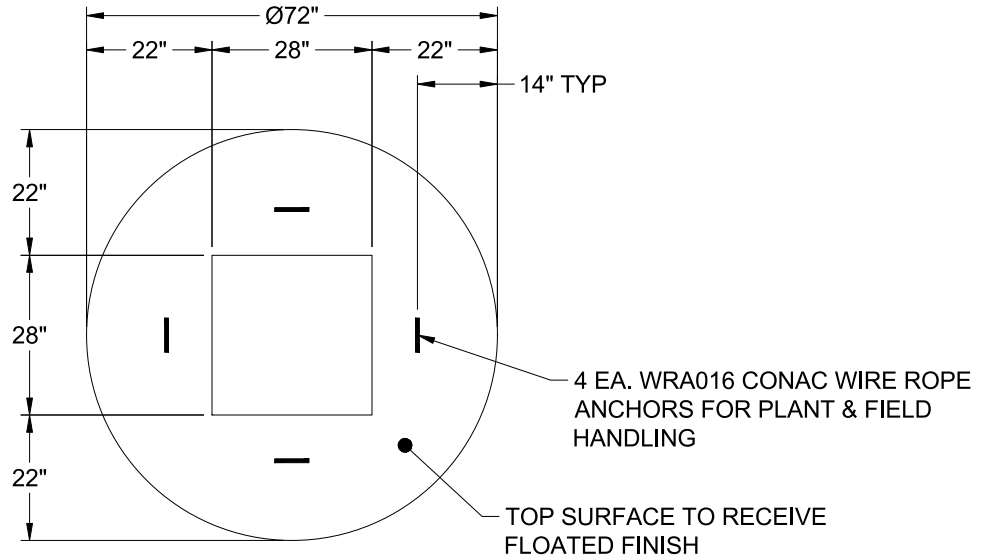

Coating (Int):
 Coating (Ext):

Seam Up: Flat
 Seam Dn: Flat

Wall Thickness: 6"

Height (Ext): 8"

Weight (Net): 2217 lb
 Volume (Net): 0.57cu.yd