

GENERAL NOTES:

1. MANUFACTURED TO ASTM C-1577-16
2. LOAD REQUIREMENTS: PER AASHTO HL-93
3. REINFORCEMENT PER ASTM C-1577-16 (GRADE 60)
4. COVER DEPTH: 0'-0"
5. CONCRETE: 5,000 PSI AT 28 DAYS
6. JOINT SEALANT: 1" BUTYL MASTIC (CS-102)
EXTERIOR JOINT WRAP: 12" WIDE (CS-212)
7. WEIGHT: 3' X 3' RCBC = 999 LBS / LF
(60" LONG SECTION = 4,994 LBS EA.)
8. GRATING SUPPLIED BY OTHERS

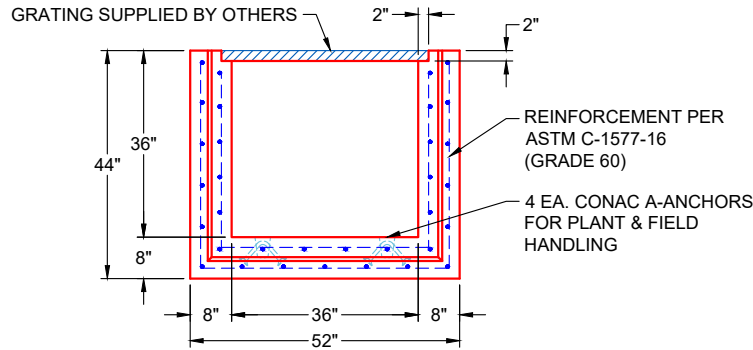

END VIEW
TYPICAL

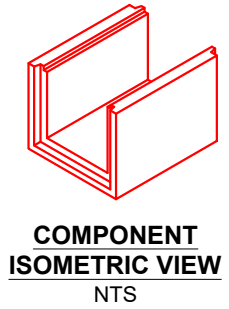
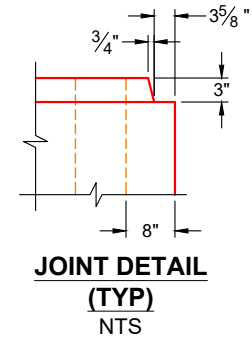

JOINT DETAIL
(TYP)
NTS

COMPONENT
ISOMETRIC VIEW
NTS

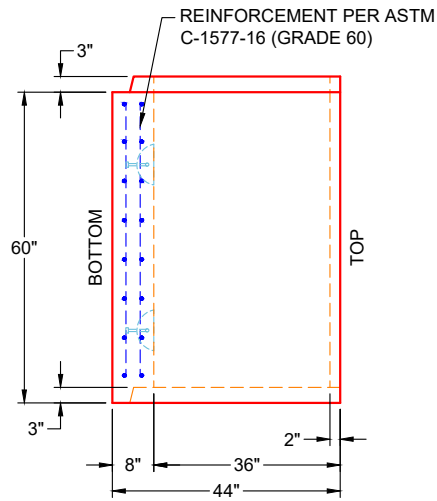

VIEW A
PC 2
(UPRIGHT IN MOLD)

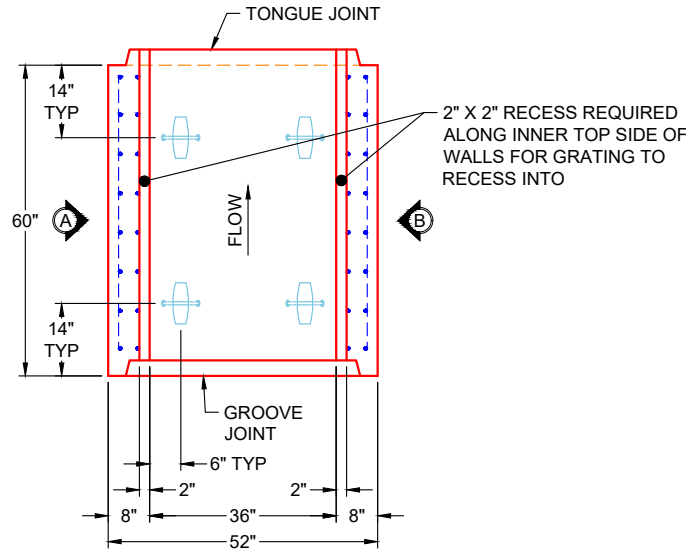

PLAN VIEW
PC 2
(UPRIGHT IN MOLD)

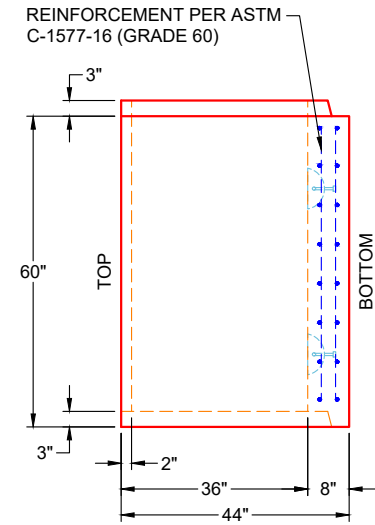

VIEW B
PC 2
(UPRIGHT IN MOLD)

REVISION INFORMATION

REV. Δ DATE: NO REVISIONS TO DATE



SUBMITTAL DRAWING:
36" X 36" X 60" BOX CULVERT (8" WALLS & NO HAUNCH)

CUSTOMER: MAC CONSTRUCTION & EXCAVATING, INC.

PROJECT: 860 PZ LANDIS RIDGE 3 MG TANK

STRUCTURE: 3 X 3 BC PIECE 2

QUOTE/SALES ORDER NO: 25-1718

CHECKED BY: B. SMITH

DRAWN BY: K. CARDWELL

DATE: 01/19/26

SCALE: NTS

PG. 1 OF 1