

KYTC STATE PRODUCT

REINFORCING CUT LIST					
BAR	QTY.	MATERIAL	LENGTH	SHAPE	TOTAL WEIGHT
(A)	3	#5 BAR	34"	STR.	9 LBS.
(B)	2	#5 BAR	48"	STR.	8 LBS.
(C)	3	#5 BAR	132"	STR.	34 LBS.
(D)	7	#5 "L" BAR	30"	BENT	44 LBS.
(E)	8	#5 "U" BAR	42"	BENT	30 LBS.
(F)	5	#5 BAR	100"	STR.	44 LBS.
(G)	8	#5 BAR	12"	STR.	8 LBS.

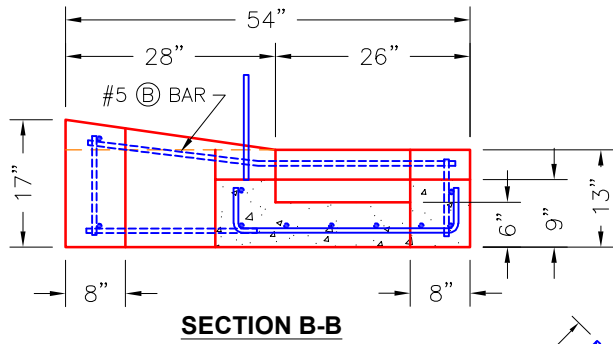
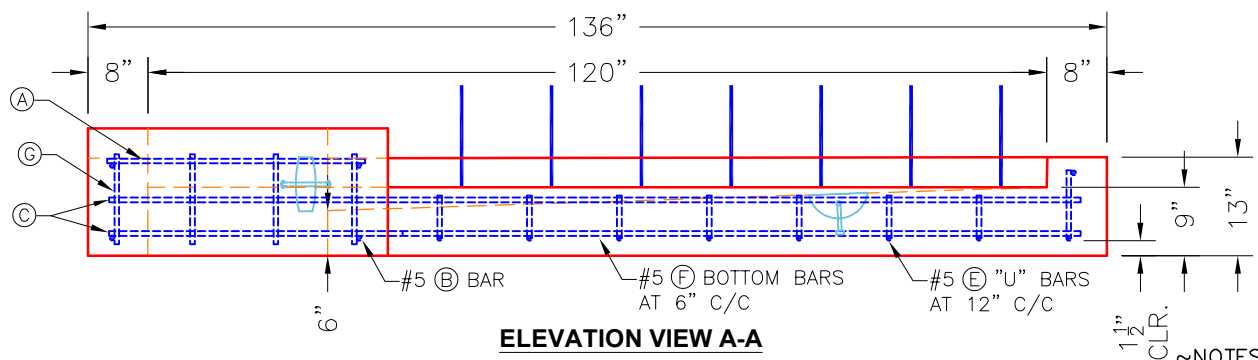
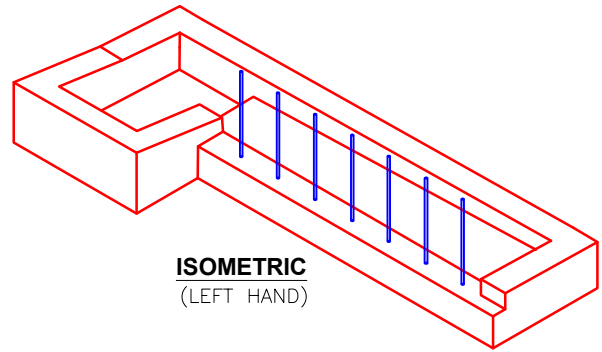
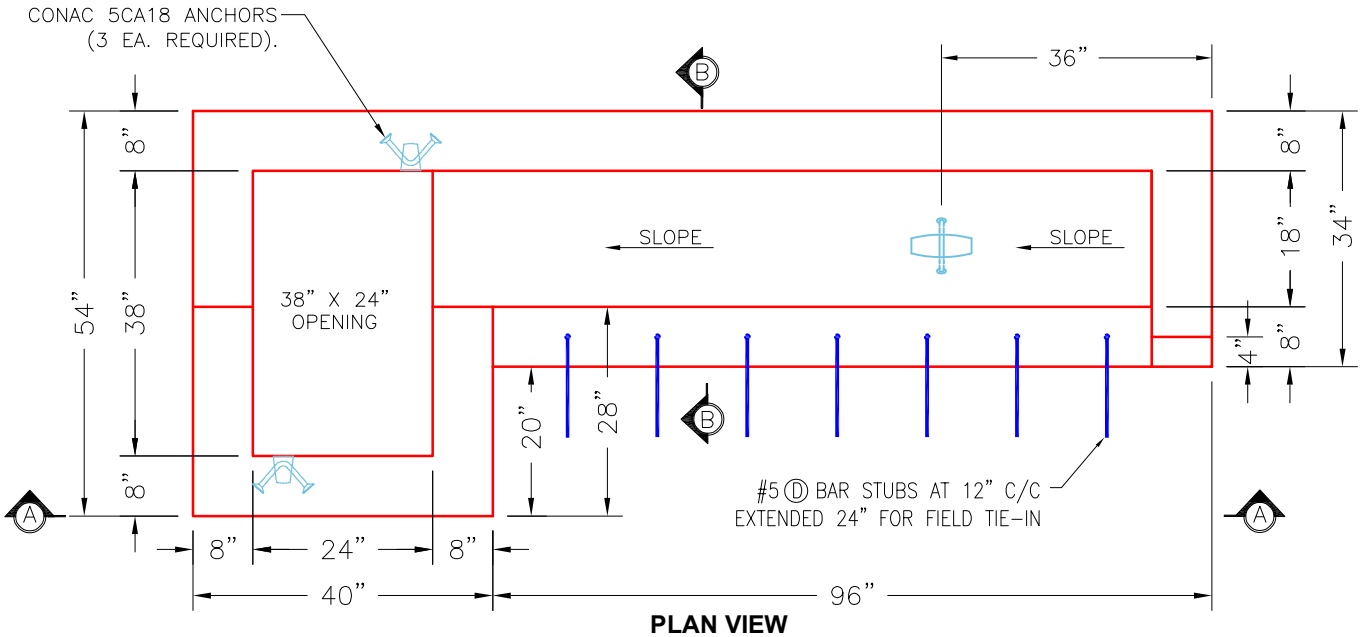

- NOTES:**
1. CONCRETE: 4,500 PSI KYTC APPROVED.
 2. REINFORCING: #5 BAR-SEE CHART (GRADE 60)
 3. REINFORCING BARS TO BE TACK WELDED OR TIED.
 4. LIFTING ANCHOR POCKETS TO BE GROUTED AFTER SETTING BY CONTRACTOR.
 5. DRAWING TO BE USED IN CONJUNCTION WITH KYTC STD. DRAWINGS RDB-230-09, RDB-231-11, RDB-240-02, AND THE STANDARD SPECIFICATIONS FOR ROAD AND BRIDGE CONSTRUCTION.
 6. TOP PHASE CAN BE SUPPLIED AS RIGHT HAND, LEFT HAND & SAG. "A" DESIGNATES SAG & "B" DESIGNATES GRADE CONDITION. "1" DESIGNATES REBAR STUBS ON ONE SIDE AND "2" DESIGNATES REBAR STUBS ON BOTH SIDES AS SHOWN.

PRODUCTION WORK ORDER		PRODUCT I.D.: CMBBIT9-B1LH	DESCRIPTION: KYTC MBI B1 TYPE 9 10' TOP PHASE (LEFT HAND)		
	QUALITY CONTROL CHECKLIST	PRODUCT VIEW: RIGHT SIDE UP	CUSTOMER: CLEARY CONSTRUCTION, INC.		
	<input type="checkbox"/> ALL DIMENSIONS CORRECT. <input type="checkbox"/> LIFTERS INSTALLED. <input type="checkbox"/> CASTING AT CORRECT LOCATION. <input type="checkbox"/> REINFORCING CORRECT. <input type="checkbox"/> LIGHT BRUSH FINISH ACCEPTABLE. <input type="checkbox"/> KYTC STANDARD THROAT CORRECT. <input type="checkbox"/> ALL PATCHWORK ACCEPTABLE.	PLANT: BEAVER DAM, KY.	PROJECT: JEFFERSON CO. (251007)		
		WEIGHT: 4,325 LBS.	STRUCTURE ID.: 5100+05 LT MBI B1 (SEC. P2)		
		TOP SECTION JOINT: N/A	SALES ORDER NO.: 25-1684		
		BOTTOM SECTION JOINT: SHIP-LAP GROOVE	PC: J. JARVIS	DRAWING: N. RICHARDS	
		QC CHECK INITIALS:	DATE: 11/20/25	SCALE: NTS	PG. 1 of 1