

Structure ID: B5

P2 MH048RS48X

MH RISER w/XYPEX T/G

P5) 24" - CASTING HEIGHT - 7" P4) 24" - XYPEX GRADE RING F/F - 4" P3) 48" - ECC XYPEX CONE w/ 24" HOLE F/G - 30" P2) 48" - MH RISER w/XYPEX T/G - 48" P1) 48" - MH BASE w/XYPEX T/n - 30" 1) JOINT WRAP PRIMER - CONSEAL CS-75 (1 gal.) 1) Conseal CS-102 1.00" (Double) 1) JOINT WRAP - 0.065"x12"x50' CONSEAL CS212 1) 48" - MH INVERT CHANNEL w/XYPEX - FULL HEIGHT 2) 48" - Conseal CS-102 1.00" (Double) 3) PSX - 12-08 NYLO	0 lb 270 lb 1981 lb 3353 lb 3282 lb 0 lb 0 lb 0 lb 1440 lb 0 lb 24 lb ----- Structure Total: 10350 lb
---	---

Structure Notes:

1. PER ASTM C478 SPECIFICATIONS.
2. CONCRETE = 4,000 PSI AT 28 DAYS.
3. CASTING BY OTHERS. (JBS-1155 F/C)
4. EXTERIOR STAINLESS STEEL JOINT STRAPS TO BE PROVIDED BY OTHERS.
5. NO STEPS.

REINFORCING PER ASTM A615 (GRADE 60).

- CONE (As .12)
- RISER (As .12)
- FLOOR (As .31) #5 BARS AT 12" C.C.E.W.

Rim: 511.95' Rim to Invert: 9.8' Slack: 0.6" Sump: 2" Step Position:

Position	Elev	Angle	Ext. (cw)	Pipe	Pipe OD	Connector	Hole	Horz Size	Up ()	Offset
Invert 1										
Invert 2										
Invert 3										
Invert 4										
Invert 5										
Invert 6										
Invert 7										
Invert 8										

RIGHT-SIDE UP VIEW (int. dimensions)

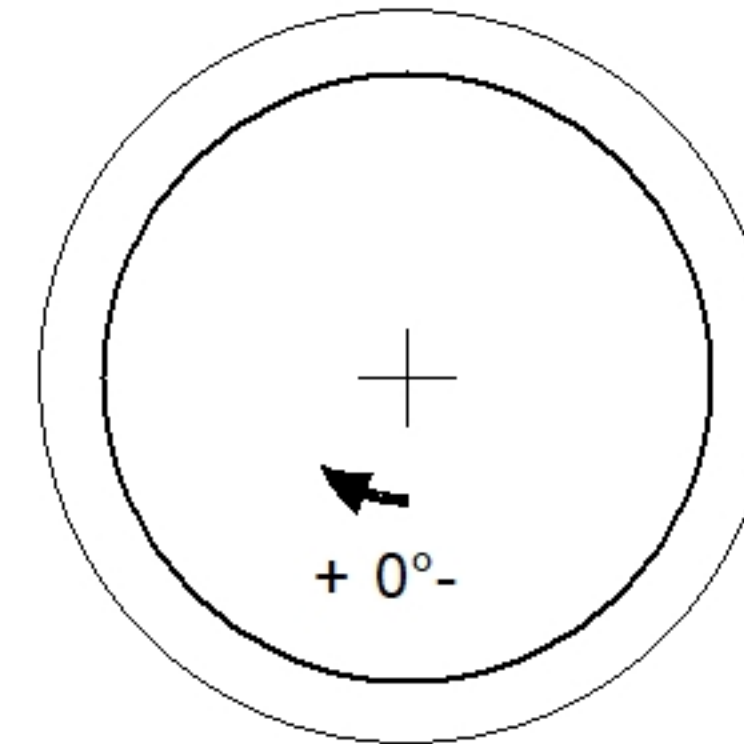
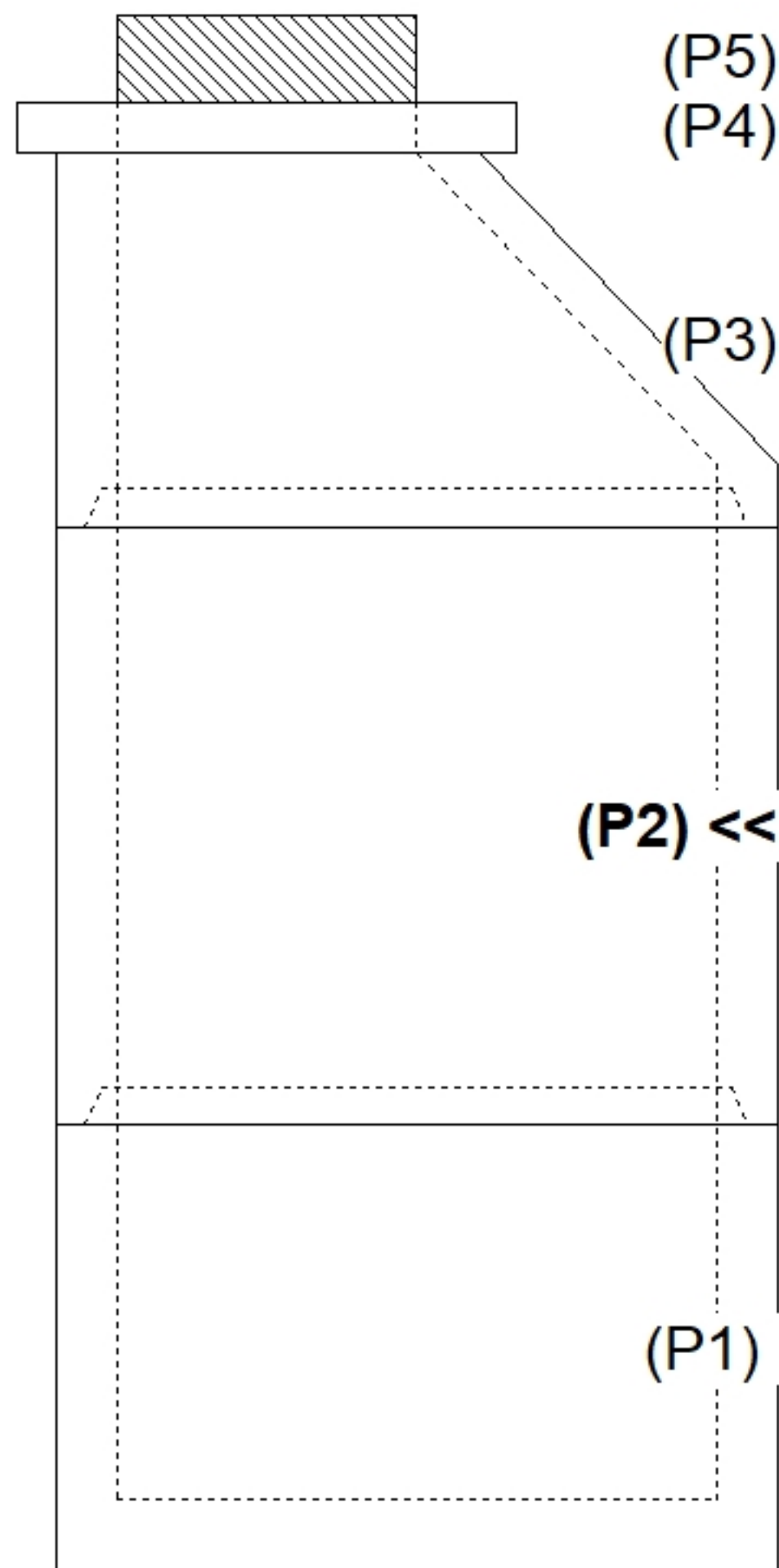

INSIDE WALL DIMENSIONS

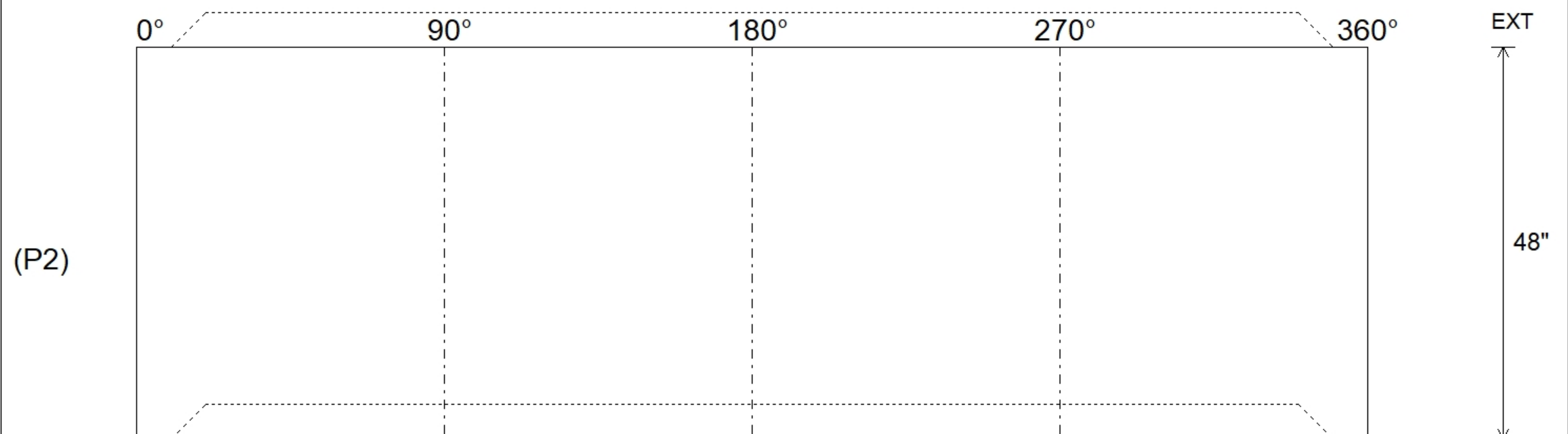

Coating (Int):	Seam Up: Tongue Seam Dn: Groove	Wall Thickness: 5" Floor Height: 0"	Height (Int): 48" Height (Ext): 48"
Coating (Ext):			Weight (Net): 3353 lb Volume (Net): 0.86cu.yd