

Job Name: 25-1511 Halfhill Estates Ph.3	Plant: Beaver Dam	Tech: J. Horsley	
Job Location: Nicholasville, KY	12/16/2025 4:37:06 PM	PC: J. Jarvis	
Contractor: Perdue Environmental Contracting Co., Inc.			

Structure ID: MH K6

P2 MH048CN30CDARED

ECC CONE w/ 24" HOLE, w/ConBlock-CDA Red F/G

P3) 24" - CASTING HEIGHT - 7"	0 lb
P2) 48" - ECC CONE w/ 24" HOLE, w/ConBlock-CDA Red F/G - 30"	1961 lb
P1) 48" - MH BASE Custom Ht, w/ConBlock-CDA Red T/n - 26"	3099 lb
1) 48" - MH INVERT CHANNEL w/ConBlock-CDA Red - FULL HEIGHT	1440 lb
1) JOINT WRAP - 0.065"x6"x50' CONSEAL CS212	0 lb
1) JOINT WRAP PRIMER - CONSEAL CS-75 (1 gal.)	0 lb
1) CASTING - HOE MC-350 F/C Sanitary	305 lb
1) 48" - Conseal CS-102 1.00" (Double)	0 lb
1) PSX - 12-08 NYLO	8 lb
5) MH Step ML-10-TDS-NCR - 10"	0 lb
Structure Total:	6813 lb

Structure Notes:

- PER ASTM C478 SPECIFICATIONS.
- CONCRETE = 4,000 PSI AT 28 DAYS.
- ADMIXTURE = CONBLOCK CDA RED.
- CASTING BY ICAST (HOE MC-350 F/C)

REINFORCING PER ASTM A615 (GRADE 60).

- CONE (As .12)
- RISER/WALLS (As .12)
- FLOOR (As .31) #5 BARS AT 12" C.C.E.W.

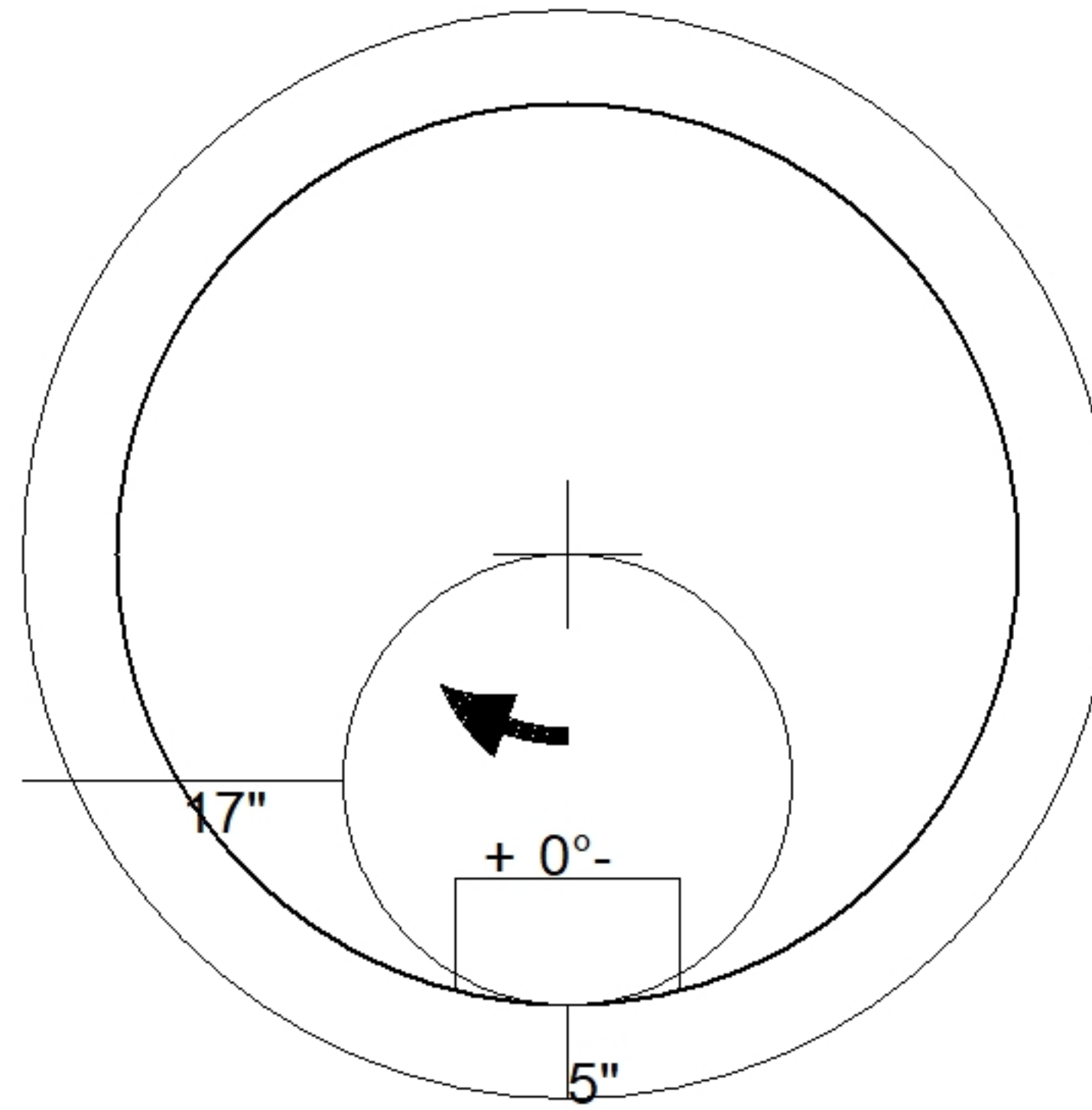

48" - ECC CONE w/ 24" HOLE, w/ConBlock-CDA Red F/G - 30" - (P2)

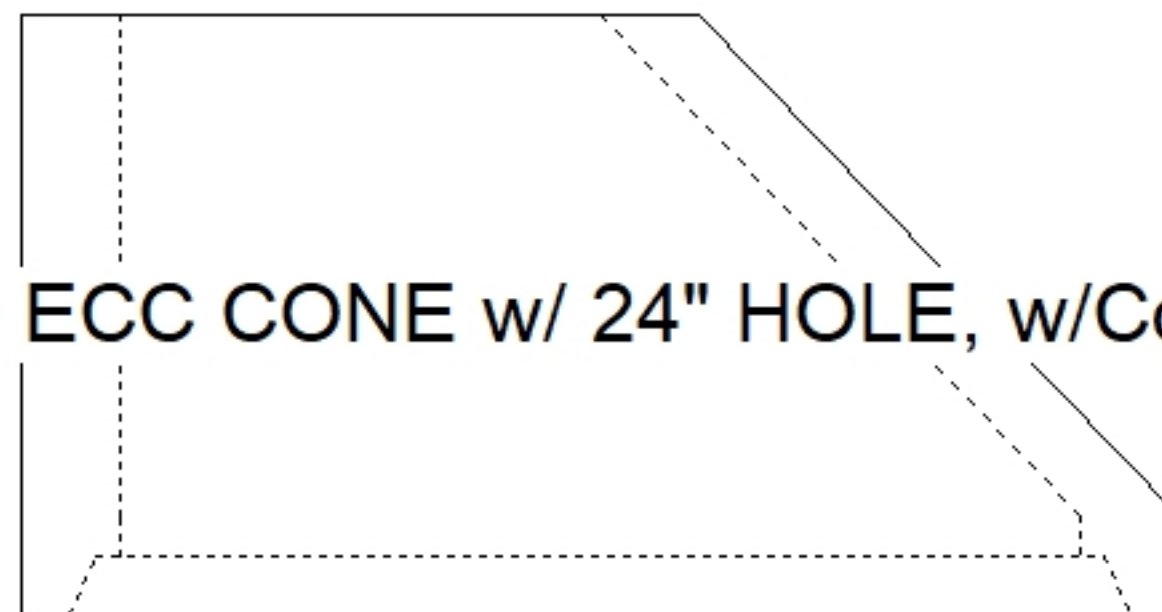

Coating (Int):	Seam Up: Flat	Wall Thickness: 5"	Height (Ext): 30"	Weight (Net): 1961 lb
Coating (Ext):	Seam Dn: Groove			Volume (Net): 0.5cu.yd