

Job Name: 25-1431 - Georgetown Commons
Job Location: Georgetown, KY
Contractor: Winwater Hartford KY Co.

PC: A. Chambers
 TECH: J. Coppage
 Plant: Beaver Dam



Structure ID: **SCI 42**
 Spec: Storm
 Type: STM.MH
 Size: 48"

Rim: 867.6'
 Invert: 861.65'
 Rim to Invert: 5.95'

Sump: 1.9"
 Floor (Top): 861.492'
 Floor Height: 6"

Floor (Bot): 860.992'
 Overall Height: 6.5'
 Slack: 1.3"

Structure Notes:

1. JR HOE HOE-360 PROVIDED BY ICAST.
2. PER ASTM C478 SPECIFICATIONS.
3. CONCRETE = 4,000 PSI AT 28 DAYS.
4. REINFORCING PER ASTM A615 (GRADE 60).
 - TOP SLAB (As .62) #5 BARS AT 6" C.C.E.W..
 - RISER/WALLS (As .12)
 - FLOOR (As .31) #5 BARS AT 12" C.C.E.W.

STRUCTURE SUMMARY:

P3) 24" x 30" - CASTING HEIGHT - 6"	0 lb
P2) 48" - MH FLAT TOP w/24"x30" Hole - 12"	1935 lb
P1) 48" - MH BASE - 54"	4471 lb
1) CASTING - HOE 360 Set (F/G/H)	362 lb
1) 48" - Conseal CS-102 1.00"	0 lb
1) 24" x 30" - Conseal CS-102 1.00"	0 lb
2) Hole - 30	0 lb
4) MH Step ML-10-TDS-NCR - 10"	0 lb
Structure Total:	6768 lb

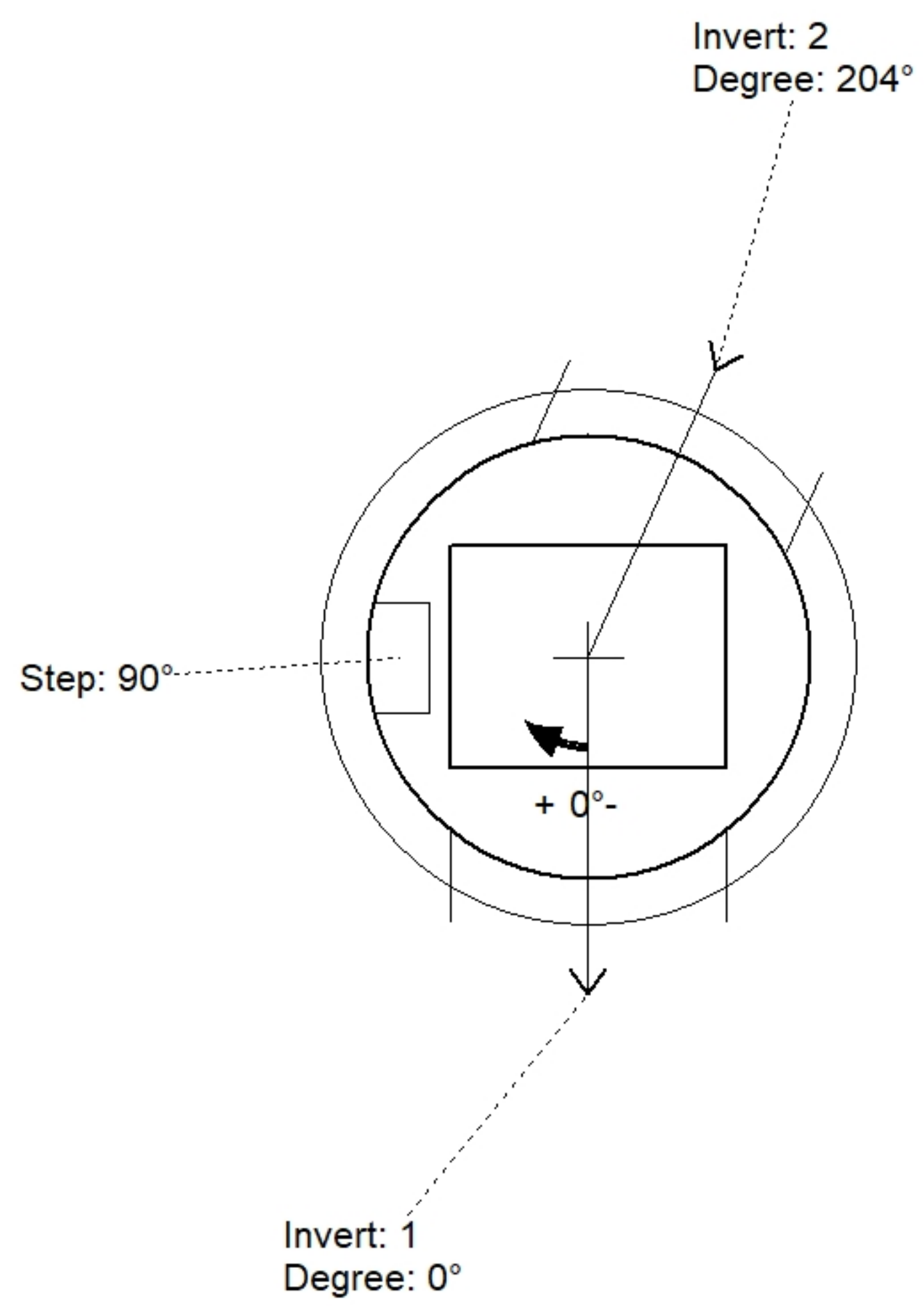

Position	Elev	Angle	Pipe	Pipe OD	Hole	Connector	Up ()	Ref
Rim	867.6'							
Reducer								
Invert 1	861.65'	0°	24" HDPE	27.8"	30"	Hole 30	0"	P1
Invert 2	861.65'	204°	24" HDPE	27.8"	30"	Hole 30	0"	P1
Invert 3								
Invert 4								
Invert 5								
Invert 6								
Invert 7								
Invert 8								

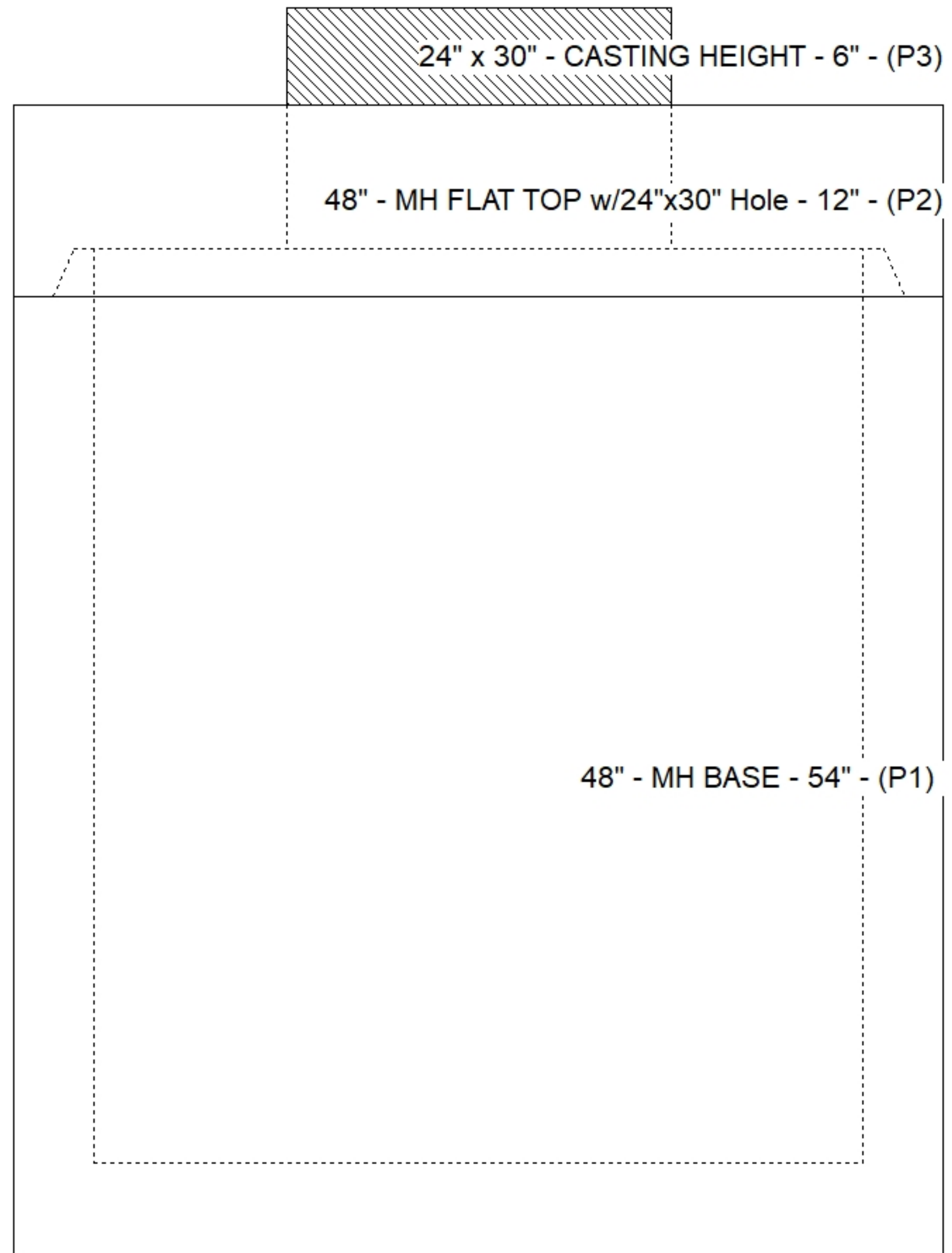

Default - Interior Dimensions

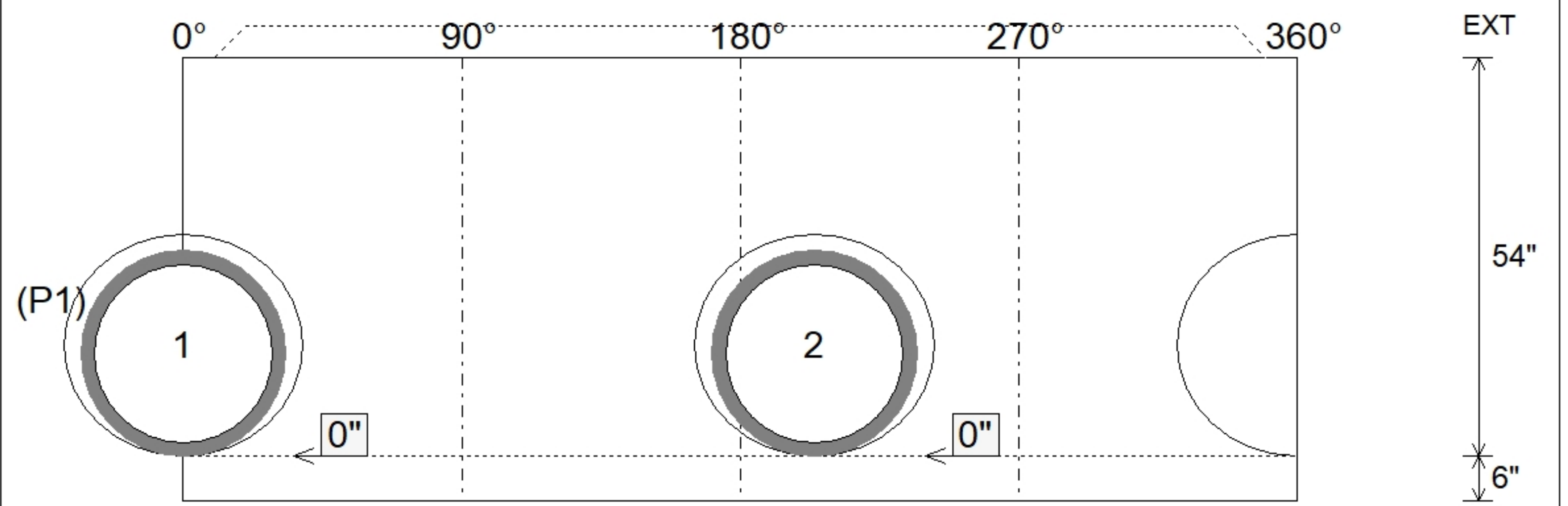

Submittal Drawing
 4/24/2026 11:00:46 AM

SUBMITTAL
 APPROVED BY: