

Job Name: 25-1431 - Georgetown Commons
 Job Location: Georgetown, KY
 Contractor: Winwater Hartford KY Co.

Plant: Beaver Dam

4/23/2026 11:30:29 AM

Tech: J. Coppage

PC: A. Chambers



Structure ID: SCI 23

P3 GR24x30x8x3

GRADE RING

- P4) 24" x 30" - CASTING HEIGHT - 6"
- P3) 24" x 30" - GRADE RING - 3"
- P2) 48" - MH FLAT TOP w/24"x30" Hole - 12"
- P1) 48" - MH BASE - 42"
- 1) CASTING - HOE 360 Set (F/G/H)
- 1) 48" - Conseal CS-102 1.00"
- 2) 24" x 30" - Conseal CS-102 1.00"
- 2) Hole - 20
- 3) MH Step ML-10-TDS-NCR - 10"

- Structure Notes:**
1. JR HOE HOE-360 PROVIDED BY ICAST.
 2. PER ASTM C478 SPECIFICATIONS.
 3. CONCRETE = 4,000 PSI AT 28 DAYS.
 4. REINFORCING PER ASTM A615 (GRADE 60).
 - TOP SLAB (As .62) #5 BARS AT 6" C.C.E.W..
 - RISER/WALLS (As .12)
 - FLOOR (As .31) #5 BARS AT 12" C.C.E.W.

Structure Total: 6573 lb

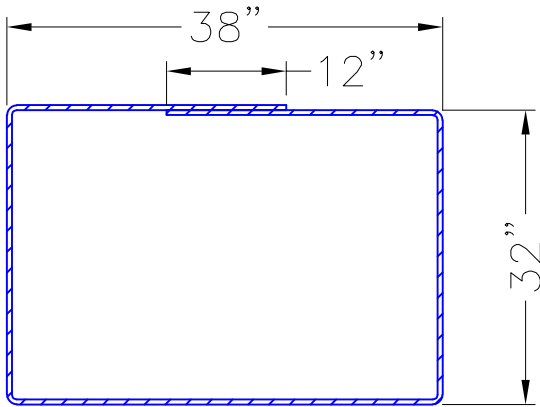

#4 BAR REINFORCING

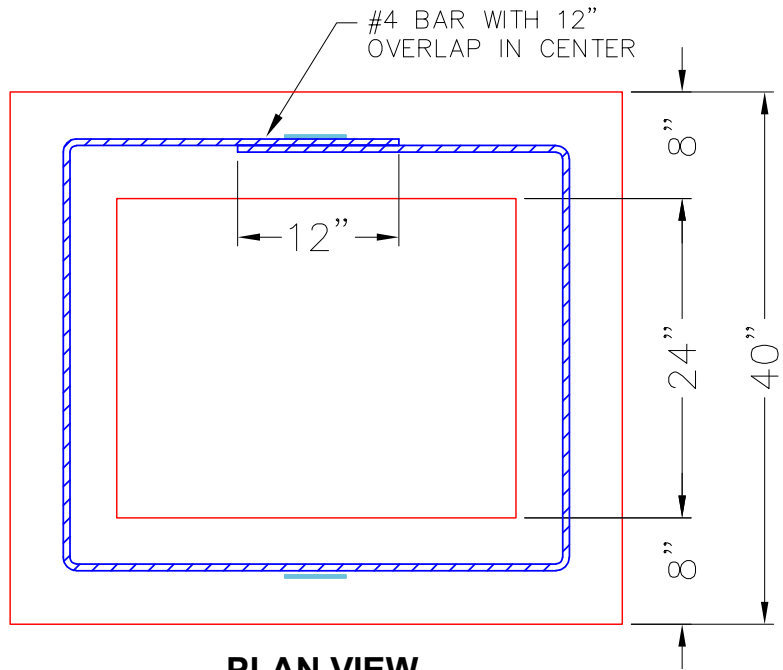

PLAN VIEW

2 EA. CONAC .8 TON $8\frac{1}{16}$ " (6MM) WIRE ROPE ANCHORS FOR HANDLING.

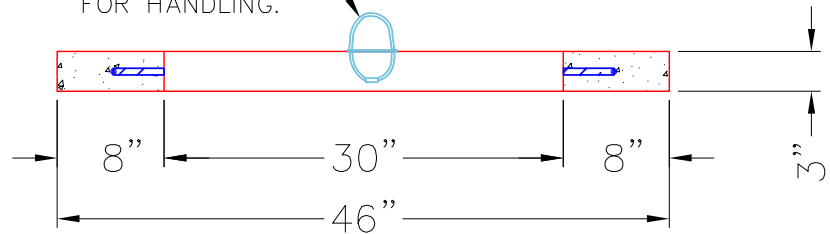

SECTION A-A

NOTES:

1. MANUFACTURED TO ASTM C-478 (LATEST REVISION).
2. CONCRETE: 4,000 PSI AT 28 DAYS.
3. REINFORCING: #4 BAR AS SHOWN (GRADE 60 KSI).
4. LIFTS: 2 EA. CONAC .8 TON WIRE ROPE ANCHORS REQUIRED.

Coating (Int):
Coating (Ext):

Seam Up: Flat
Seam Dn: Flat

Wall Thickness: 8"

Height (Ext): 3"

Weight (Net): 282 lb
Volume (Net): 0.07cu.yd