

Job Name: 25-1431 - Georgetown Commons  
 Job Location: Georgetown, KY  
 Contractor: Winwater Hartford KY Co.

Plant: Beaver Dam

4/23/2026 11:30:46 AM

Tech: J. Coppage

PC: A. Chambers



**Structure ID: DCI 113**

**P3 GR24x36x8x4**

**GRADE RING**

- P4) 24" x 36" - CASTING HEIGHT - 6"
- P3) 24" x 36" - GRADE RING - 4"
- P2) 72" - MH FLAT TOP w/24"x36" Hole - 15"
- P1) 72" - MH BASE - 84"
- 1) CASTING - HOE 470 SET (F/G/H)
- 1) 72" - Conseal CS-102 1.00"
- 2) 24" x 36" - Conseal CS-102 1.00"
- 2) Hole - 30
- 2) Hole - 46
- 7) MH Step ML-10-TDS-NCR - 10"

- Structure Notes:**
1. JR HOE HOE-470 PROVIDED BY ICAST.
  2. PER ASTM C478 SPECIFICATIONS.
  3. CONCRETE = 4,000 PSI AT 28 DAYS.
  4. REINFORCING PER ASTM A615 (GRADE 60).  
 - TOP SLAB (As .62) #5 BARS AT 6" C.C.E.W..  
 - RISER/WALLS (As .18)  
 - FLOOR (As .37) #5 BARS AT 10" C.C.E.W.

Structure Total: 18535 lb

**NOTES:**

1. MANUFACTURED TO ASTM C-478 (LATEST REVISION).
2. CONCRETE = 4,000 PSI AT 28 DAYS.
3. REINFORCING: #4 BAR AS SHOWN (GRADE 60 KSI).
4. LIFTS: 2 EA. CONAC .8 TON WIRE ROPE ANCHORS REQUIRED.

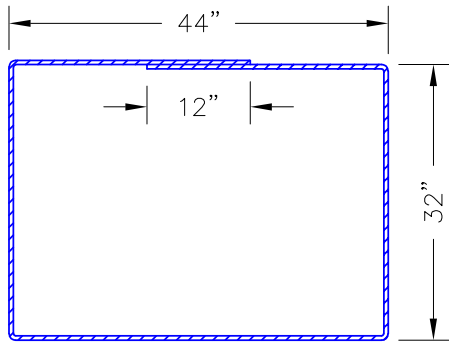

**#4 BAR REINFORCING**

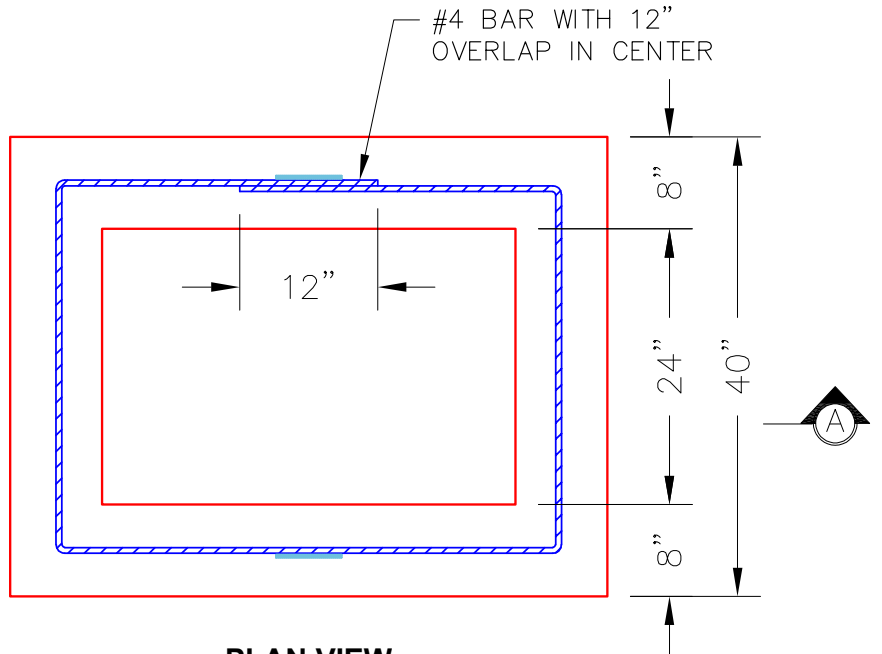

**PLAN VIEW**

2 EA. CONAC .8 TON  $8\frac{1}{16}$ " (6MM) WIRE ROPE ANCHORS REQUIRED—MINIMUM.

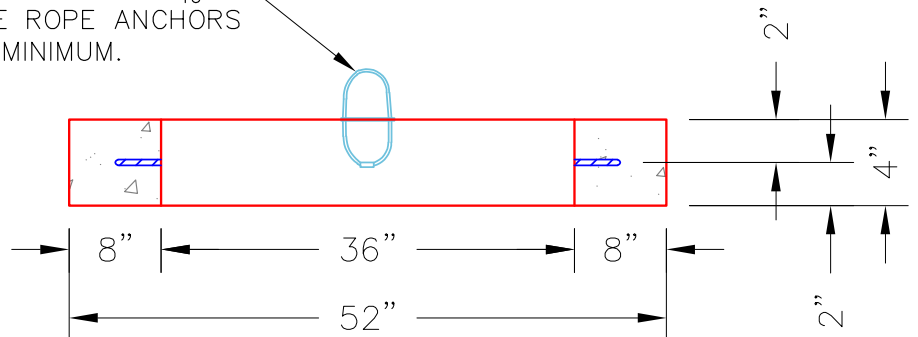

**SECTION A-A**

Coating (Int):  
Coating (Ext):

Seam Up: Flat  
Seam Dn: Flat

Wall Thickness: 8"

Height (Ext): 4"

Weight (Net): 408 lb  
Volume (Net): 0.1cu.yd