

THIS DRAWING IS INTENDED TO BE PRINTED IN COLOR.

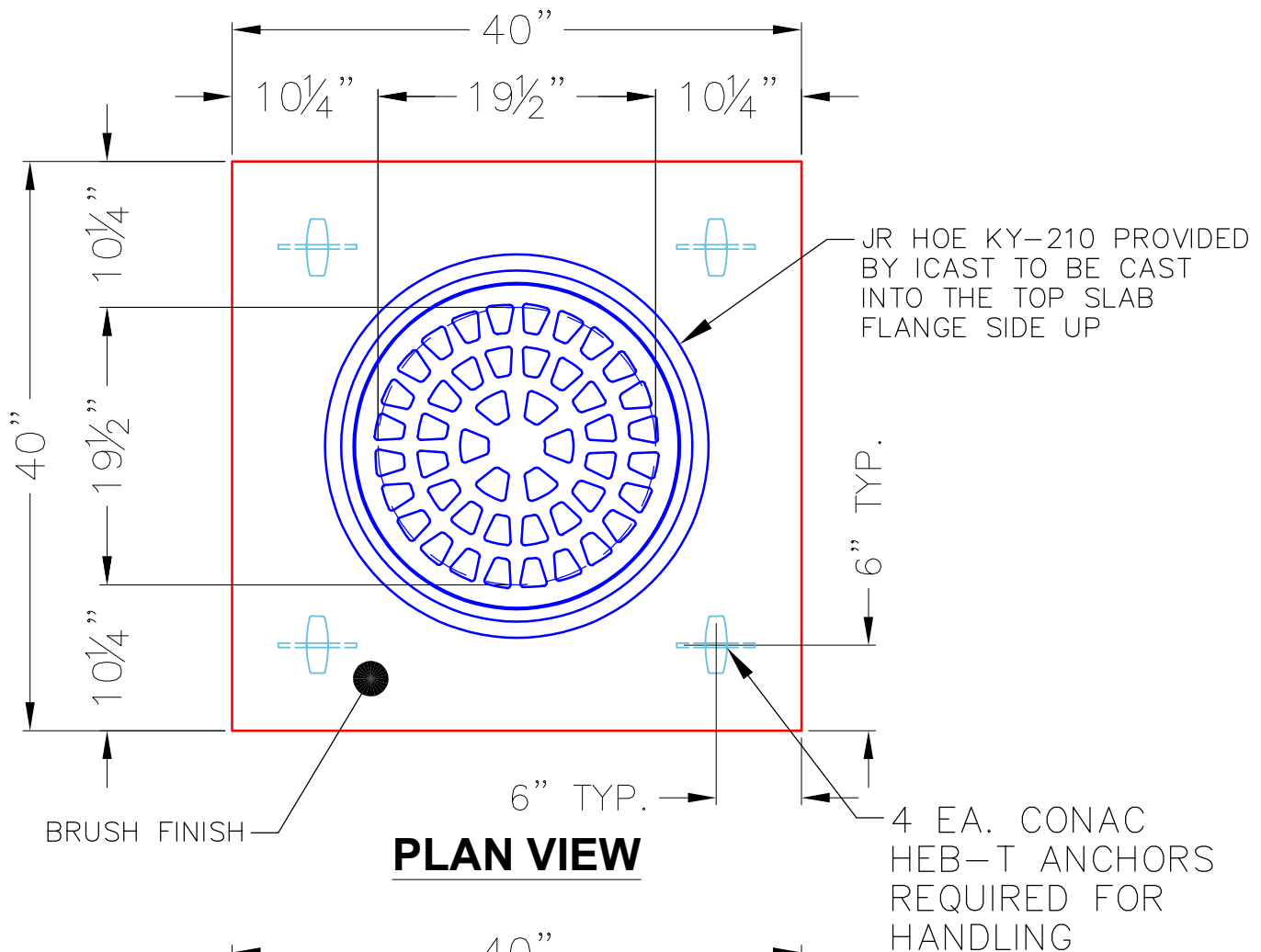

**PLAN VIEW**

**TOP VIEW**

**NOTES:**

1. MANUFACTURED TO ASTM C-913 (LATEST REVISION).
2. CONCRETE: 5,000 PSI AT 28 DAYS.
3. REINFORCING: #5 BAR @ 6" O.C. E.W. (GRADE 60).

PRODUCTION WORK ORDER		PRODUCT I.D.: BX024024-08LD08S	DESCRIPTION: 40" X 40" X 8" THK TOP SLAB W/ KY-210		
	QUALITY CONTROL CHECKLIST	PRODUCT VIEW: RIGHT SIDE UP	CUSTOMER: HALL CONTRACTING OF KENTUCKY INC.		
	<input type="checkbox"/> ALL DIMENSIONS CORRECT.	PLANT: BEAVER DAM, KY.	PROJECT: UPS BUILDING 1860		
	<input type="checkbox"/> LIFTERS INSTALLED.	WEIGHT: 770 LBS.	STRUCTURE: DBI 17		
	<input type="checkbox"/> HOLE LOCATION CORRECT.	TOP SECTION JOINT: N/A	QUOTE/SALES ORDER NO: 25-1308		
	<input type="checkbox"/> REINFORCING CORRECT.	BASE SECTION JOINT: FLAT	PC: J. JARVIS	DRAWING: J. COPPAGE	
	<input type="checkbox"/> FINISH ON SLAB SURFACE UNIFORM.	QC CHECK INITIALS:	DATE: 11/10/25	SCALE: NTS	PG. 1 of 1
<input type="checkbox"/> OUTSIDE TOP EDGE TROWELLED.					
<input type="checkbox"/> GROOVE JOINT INSTALLED.					