

Job Name: 25-1267B Grocery Owensboro KY
Job Location: Owensboro, KY
Contractor: Winwater Hartford KY Co.

PC: A. Chambers
 TECH: J. Coppage
 Plant: Beaver Dam



Structure ID: **CB-A6**
 Spec: Storm
 Type: STM.MH
 Size: 60"

Rim: 403.3'
 Invert: 398.84'
 Rim to Invert: 4.46'

Sump: 2.85"
 Floor (Top): 398.603'
 Floor Height: 8"

Floor (Bot): 397.936'
 Overall Height: 5.333'
 Slack: 0.37"

Structure Notes:

1. JR HOE HOE-468 PROVIDED BY ICAST.
2. PER ASTM C478 SPECIFICATIONS.
3. CONCRETE = 4,000 PSI AT 28 DAYS.
4. REINFORCING PER ASTM A615 (GRADE 60).
 - TOP SLAB (As .62) #5 BARS AT 6" C.C.E.W..
 - RISER/WALLS (As .18)
 - FLOOR (As .37) #5 BARS AT 10" C.C.E.W.

STRUCTURE SUMMARY:

P3) 30" x 30" - CASTING HEIGHT - 4"	0 lb
P2) 60" - MH FLAT TOP w/30"x30" Hole - 8"	2239 lb
P1) 60" - MH BASE Custom Ht - 44"	5760 lb
1) CASTING - HOE 468 F/G	489 lb
1) 60" - SGL 1"x14.5' Butyl (2x)	0 lb
1) DOGHOUSE INVRTD - 44"x44"	0 lb
1) Hole - 38	0 lb
3) MH Step ML-10-TDS-NCR - 10"	0 lb
Structure Total:	8488 lb

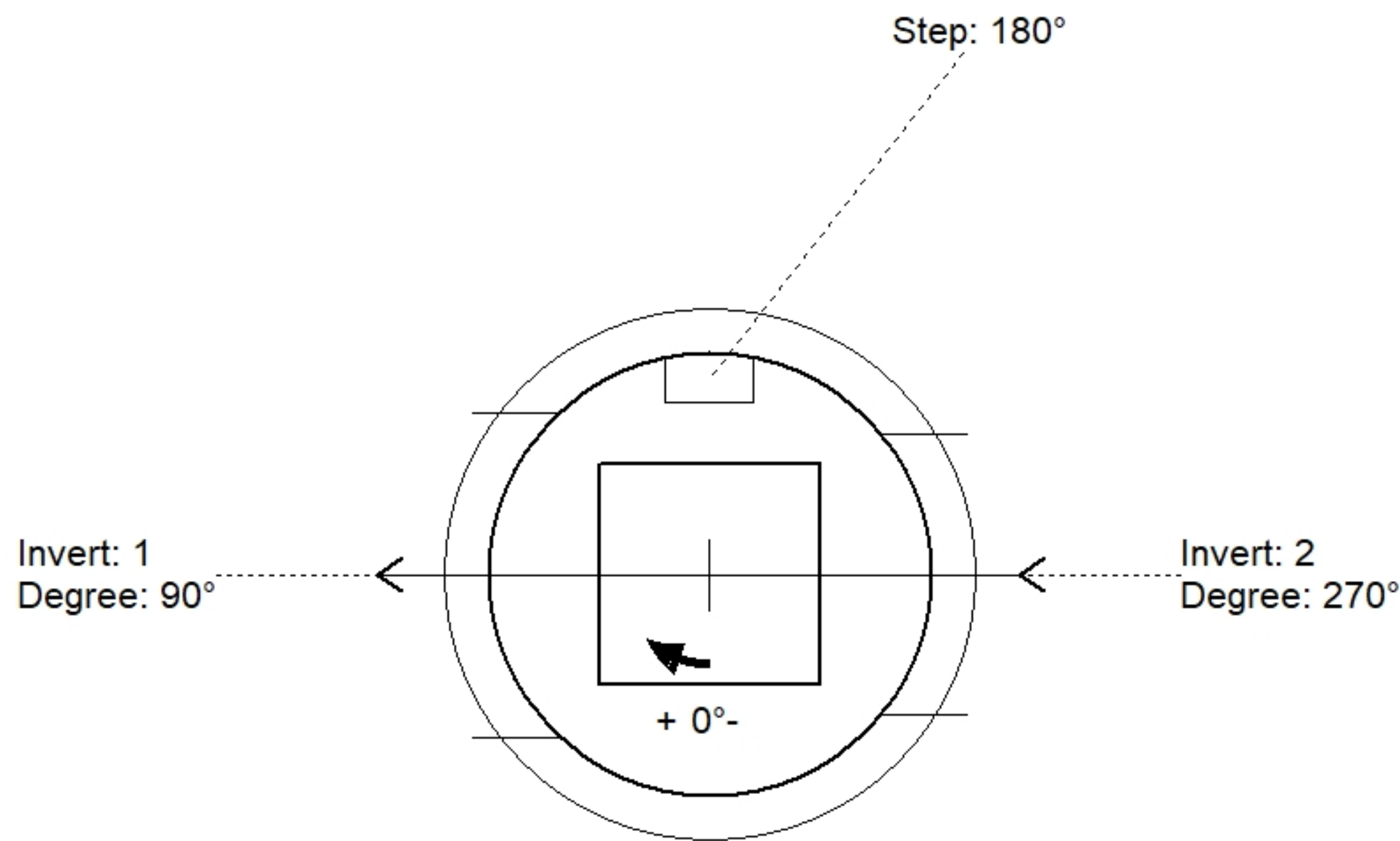

Position	Elev	Angle	Pipe	Pipe OD	Hole	Connector	Up ()	Ref
Rim	403.3'							
Reducer								
Invert 1	398.84'	90°	36" HDPE	41.7"	44" x 44"	DOGHOUSE INVRTD 44"x44"	0"	P1
Invert 2	398.84'	270°	30" HDPE	35.1"	38"	Hole 38	0.3"	P1
Invert 3								
Invert 4								
Invert 5								
Invert 6								
Invert 7								
Invert 8								

Default - Interior Dimensions

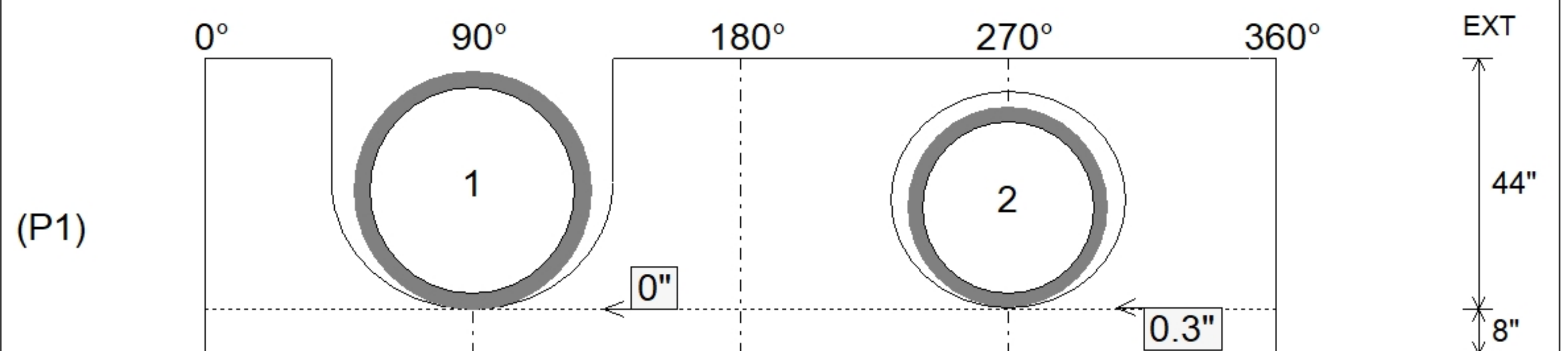
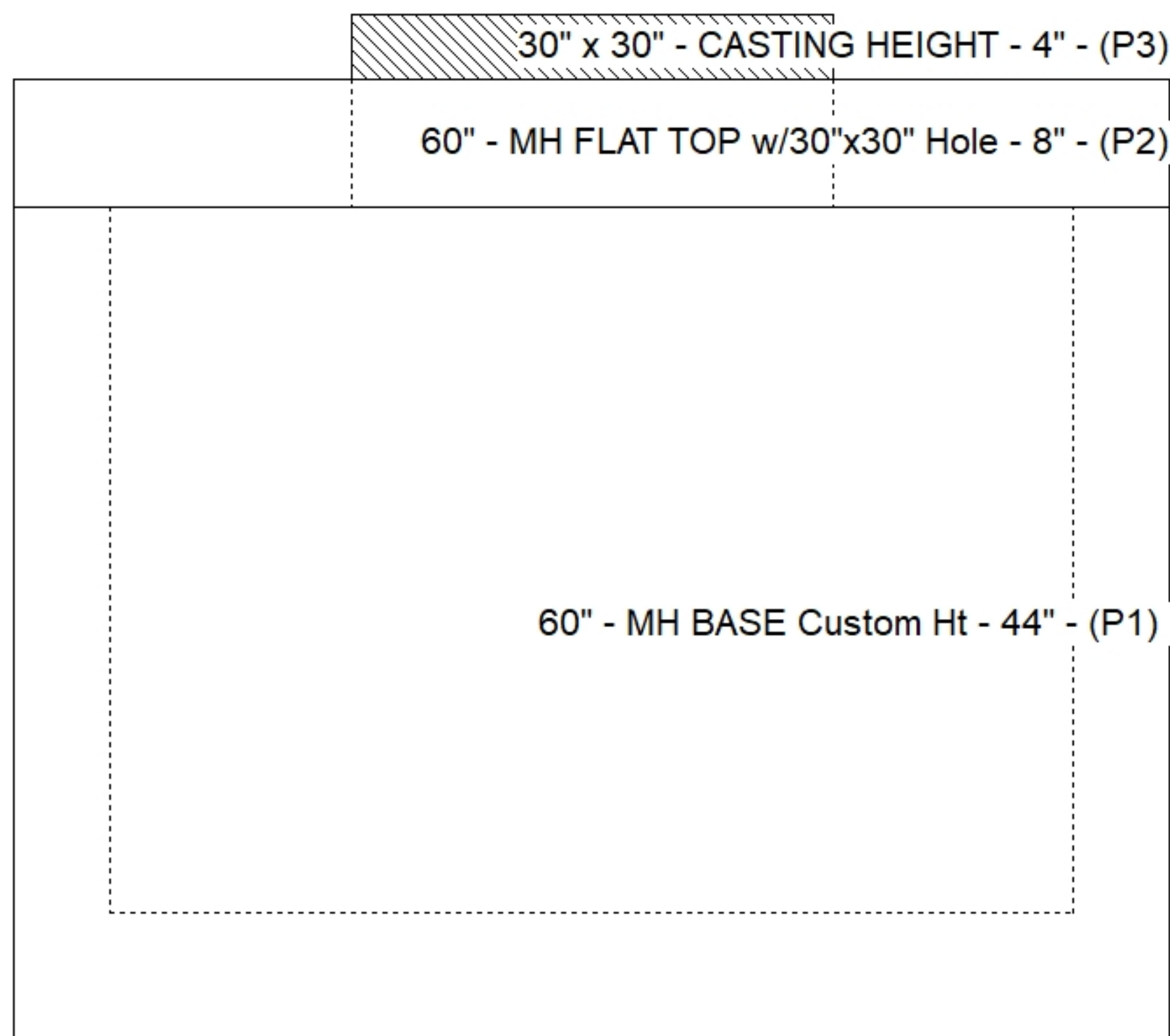

Submittal Drawing
 10/9/2025 10:40:11 AM

SUBMITTAL
 APPROVED BY: