

Job Name: 25-1172 - Midland Farms
 Job Location: Somerset, KY 45203
 Contractor: Weddle Enterprises, Inc

Plant: 100
 12/13/2025 11:43:27 AM

Tech: J. Horsley - F
 PC: C. Goff



Structure ID: CB 6

P2 MH048LD12-18x36 RECT

MH FLAT TOP w/18"x36" Hole F/G

- P3) 18" x 36" - CASTING HEIGHT - 5.5"
- P2) 48" - MH FLAT TOP w/18"x36" Hole F/G - 12"
- P1) 48" - MH BASE T/n - 30"
- 1) 48" - Conseal CS-102 1.00"
- 1) 18" x 36" - Conseal CS-102 1.00"
- 1) Hole - 20"

0 lb
 2008 lb
 3291 lb
 0 lb
 0 lb
 0 lb

 0 lb
 Structure Total: 5299 lb

- Structure Notes:**
1. PER ASTM C-478 SPECIFICATIONS
 2. CONCRETE: 4,000 PSI AT 28 DAYS
 3. REINFORCEMENT: PER ASTM A615
 4. NO STEPS & NO INVERT CHANNEL
 5. CASTING SUPPLIED BY OTHERS (HOE 580-A FRAME & GRATE)
 6. LIFTERS: 4 EA. WRA016 CONAC WIRE ROPE ANCHORS FOR PLANT & FIELD HANDLING

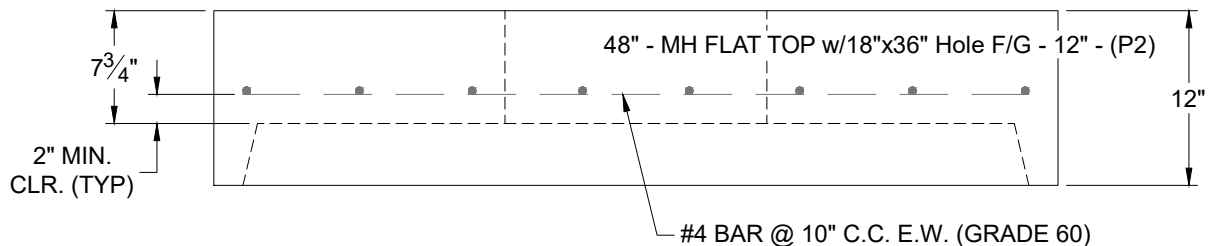
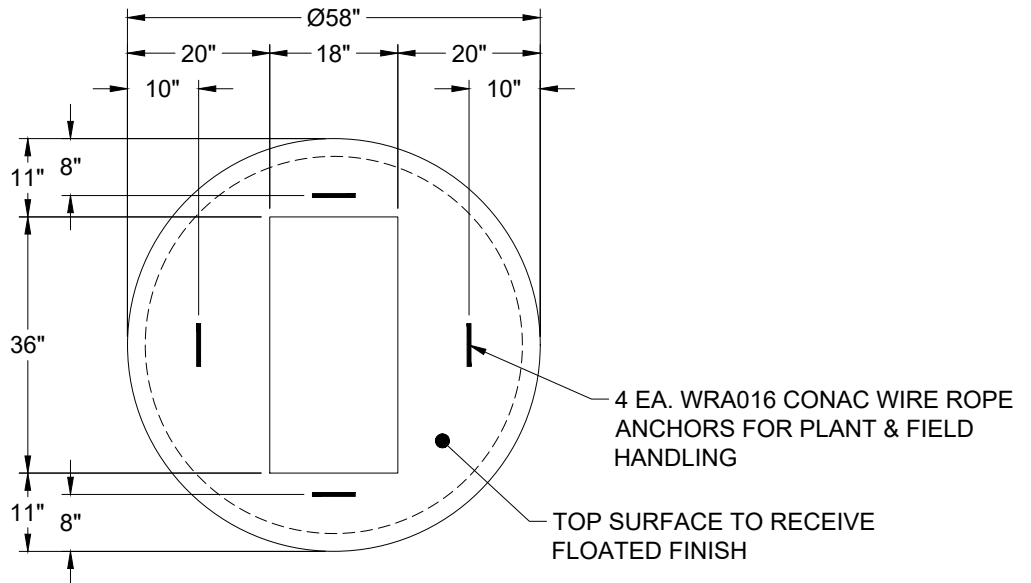

Coating (Int):
 Coating (Ext):

Seam Up: Flat
 Seam Dn: Groove

Wall Thickness: 5"

Height (Ext): 12"

Weight (Net): 2008 lb
 Volume (Net): 0.51cu.yd