



Structure ID: SAT-2 - SAT Down Range Power Center

P5 BLK24X24X72B

2' x 2' x 6' Bottom Block - 2' x 2' x 6' Bottom Block - 24" x 24"

GENERAL NOTES:

1. MANUFACTURED TO ASTM C-913 (LATEST REVISION).
2. CONCRETE: 4,000 PSI AT 28 DAYS.
3. REINFORCING: 6 X #5 BAR AS SHOWN BELOW. PER ASTM A615 (GRADE 60).
4. 1/2" CHAMFER ON ALL EXPOSED EDGES.
5. WEIGHT:
TOTAL - 3,570 LBS EACH
6. 9 TOTAL REQUIRED
7. 5,000 LBS LIFTING ANCHOR

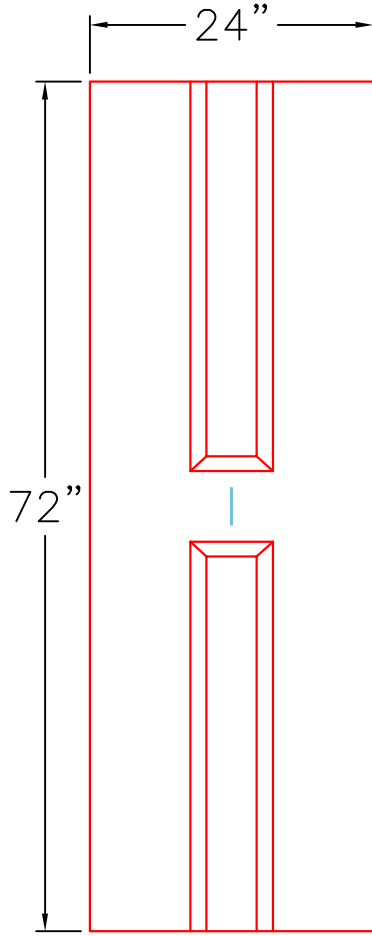

TOP VIEW

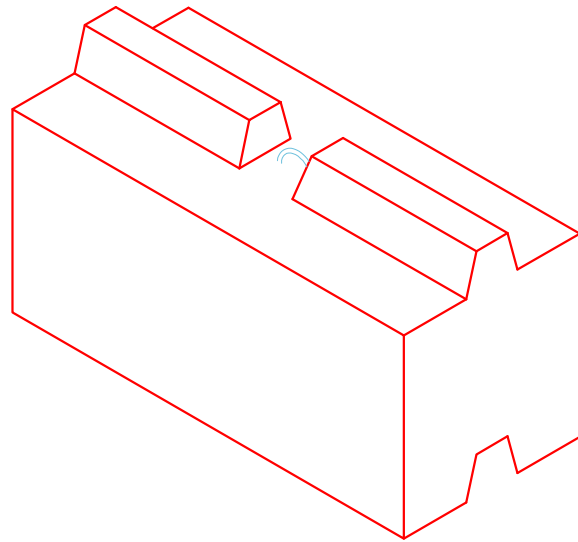

ISO VIEW

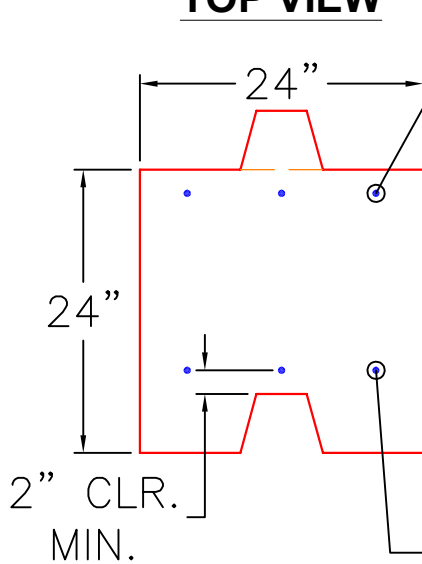

FRONT VIEW

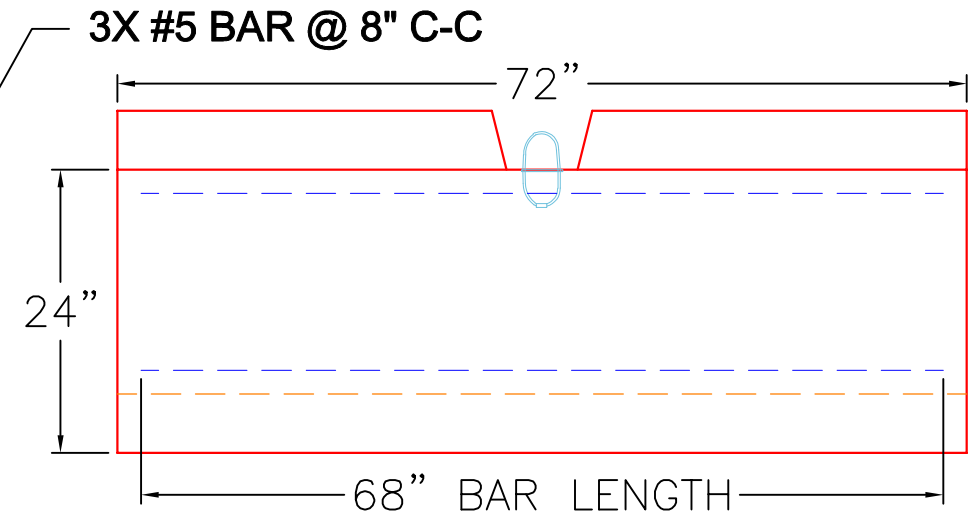

RIGHT SIDE