



Structure ID: MIT-R - MIT Modular Wall/Footing Right

P1 CVBS

32" x 78" MIT Section A - 32" x 78" MIT Section A - 32" x 78"

FIRST POUR DRAWING

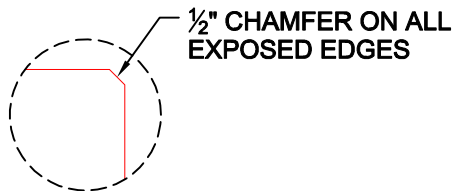

DETAIL A

GENERAL NOTES:

1. MANUFACTURED TO ASTM C-913 (LATEST REVISION).
2. CONCRETE: 4,000 PSI AT 28 DAYS.
3. REINFORCING: #5 BAR @ 12" C-C E.W. SEE REINFORCEMENT CUT SHEET FOR ADDITIONAL INFORMATION. PER ASTM A615 (GRADE 60).
4. 1/2" CHAMFER ON ALL EXPOSED EDGES.
5. WEIGHT:
FIRST POUR - 707 LBS
 SECOND POUR - 511 LBS
 TOTAL - 1,218 LBS EACH
6. 48 TOTAL REQUIRED

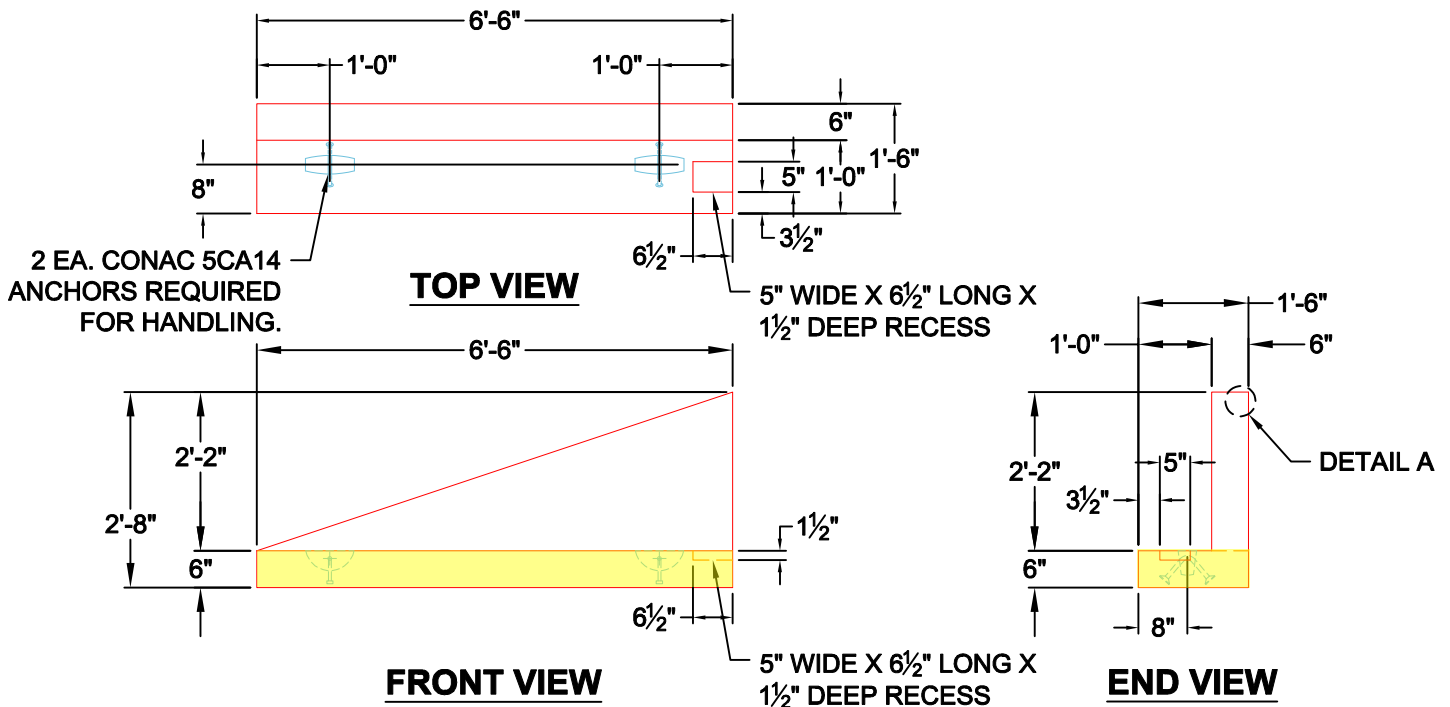

FRONT VIEW

END VIEW



Structure ID: MIT-R - MIT Modular Wall/Footing Right

P1 CVBS

32" x 78" MIT Section A - 32" x 78" MIT Section A - 32" x 78"

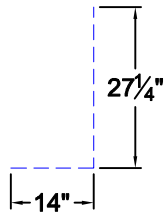

BAR - B
 #5 BAR (GRADE 60)
 TOTAL LENGTH - 41.25"
 (1) - TOTAL REQUIRED

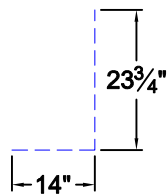

BAR - C
 #5 BAR (GRADE 60)
 TOTAL LENGTH - 37.75"
 (1) - TOTAL REQUIRED

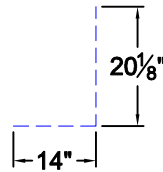

BAR - D
 #5 BAR (GRADE 60)
 TOTAL LENGTH - 34.125"
 (1) - TOTAL REQUIRED

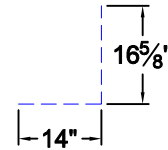

BAR - E
 #5 BAR (GRADE 60)
 TOTAL LENGTH - 30.625"
 (1) - TOTAL REQUIRED

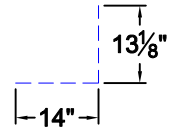

BAR - F
 #5 BAR (GRADE 60)
 TOTAL LENGTH - 27.125"
 (1) - TOTAL REQUIRED

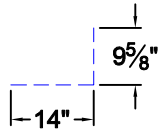

BAR - G
 #5 BAR (GRADE 60)
 TOTAL LENGTH - 23.625"
 (1) - TOTAL REQUIRED

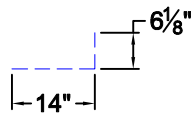

BAR - H
 #5 BAR (GRADE 60)
 TOTAL LENGTH - 20.125"
 (1) - TOTAL REQUIRED

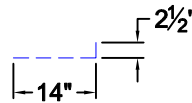

BAR - I
 #5 BAR (GRADE 60)
 TOTAL LENGTH - 16.5"
 (1) - TOTAL REQUIRED

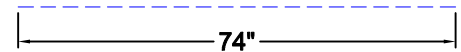

BAR - A
 #5 BAR (GRADE 60)
 (3) - TOTAL REQUIRED

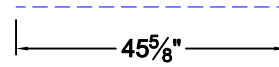

BAR - J
 #5 BAR (GRADE 60)
 (1) - TOTAL REQUIRED

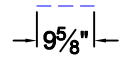

BAR - K
 #5 BAR (GRADE 60)
 (1) - TOTAL REQUIRED

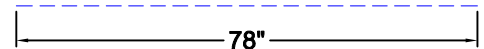

BAR - L
 #5 BAR (GRADE 60)
 (1) - TOTAL REQUIRED

REINFORCEMENT CUT SHEET

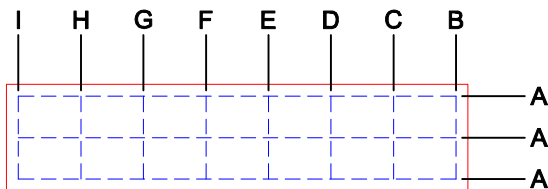

TOP VIEW

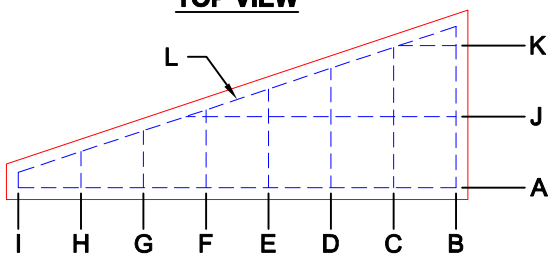

FRONT VIEW

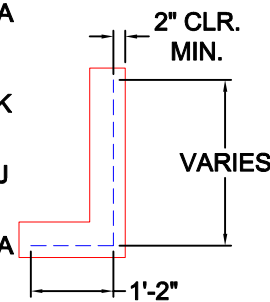

END VIEW

GENERAL NOTES:

1. MANUFACTURED TO ASTM C-913 (LATEST REVISION).
2. CONCRETE: 4,000 PSI AT 28 DAYS.
3. REINFORCING: #5 BAR @ 12" C-C E.W. SEE REINFORCEMENT CUT SHEET FOR ADDITIONAL INFORMATION. PER ASTM A615 (GRADE 60).
4. 1/2" CHAMFER ON ALL EXPOSED EDGES.
5. WEIGHT:
 FIRST POUR - 707 LBS
 SECOND POUR - 511 LBS
 TOTAL - 1,218 LBS EACH
6. 48 TOTAL REQUIRED