



**Structure ID: MIT-L - MIT Modular Wall/Footing Left**

**P1 CVBS**

**32" x 78" MIT Section A - 32" x 78" MIT Section A - 32" x 78"**

**FIRST POUR DRAWING**

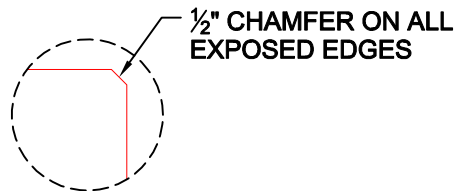

**DETAIL A**

**GENERAL NOTES:**

1. MANUFACTURED TO ASTM C-913 (LATEST REVISION).
2. CONCRETE: 4,000 PSI AT 28 DAYS.
3. REINFORCING: #5 BAR @ 12" C-C E.W. SEE REINFORCEMENT CUT SHEET FOR ADDITIONAL INFORMATION. PER ASTM A615 (GRADE 60).
4. 1/2" CHAMFER ON ALL EXPOSED EDGES.
5. WEIGHT:  
**FIRST POUR - 707 LBS**  
 SECOND POUR - 511 LBS  
 TOTAL - 1,218 LBS EACH
6. 48 TOTAL REQUIRED

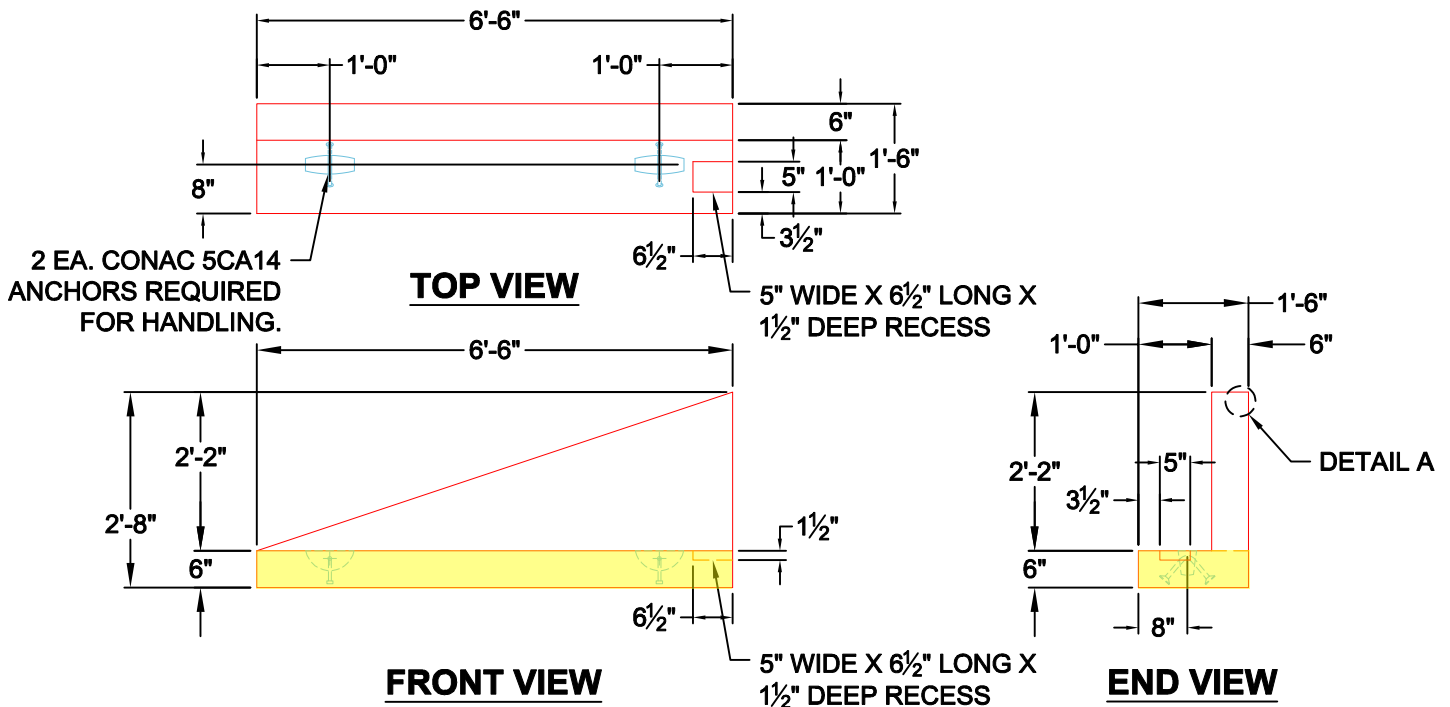

**FRONT VIEW**

**END VIEW**



**Structure ID: MIT-L - MIT Modular Wall/Footing Left**

**P1 CVBS**

**32" x 78" MIT Section A - 32" x 78" MIT Section A - 32" x 78"**

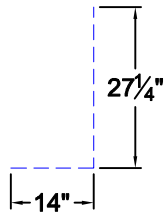

**BAR - B**

#5 BAR (GRADE 60)  
 TOTAL LENGTH - 41.25"  
 (1) - TOTAL REQUIRED

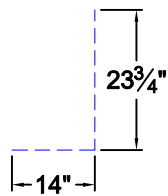

**BAR - C**

#5 BAR (GRADE 60)  
 TOTAL LENGTH - 37.75"  
 (1) - TOTAL REQUIRED

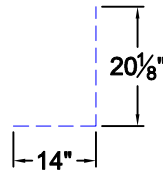

**BAR - D**

#5 BAR (GRADE 60)  
 TOTAL LENGTH - 34.125"  
 (1) - TOTAL REQUIRED

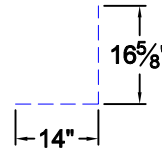

**BAR - E**

#5 BAR (GRADE 60)  
 TOTAL LENGTH - 30.625"  
 (1) - TOTAL REQUIRED

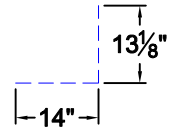

**BAR - F**

#5 BAR (GRADE 60)  
 TOTAL LENGTH - 27.125"  
 (1) - TOTAL REQUIRED

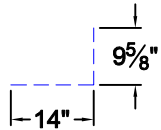

**BAR - G**

#5 BAR (GRADE 60)  
 TOTAL LENGTH - 23.625"  
 (1) - TOTAL REQUIRED

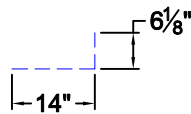

**BAR - H**

#5 BAR (GRADE 60)  
 TOTAL LENGTH - 20.125"  
 (1) - TOTAL REQUIRED

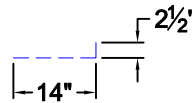

**BAR - I**

#5 BAR (GRADE 60)  
 TOTAL LENGTH - 16.5"  
 (1) - TOTAL REQUIRED

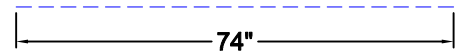

**BAR - A**

#5 BAR (GRADE 60)  
 (3) - TOTAL REQUIRED

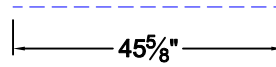

**BAR - J**

#5 BAR (GRADE 60)  
 (1) - TOTAL REQUIRED

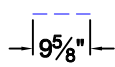

**BAR - K**

#5 BAR (GRADE 60)  
 (1) - TOTAL REQUIRED

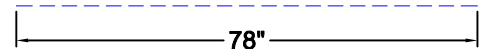

**BAR - L**

#5 BAR (GRADE 60)  
 (1) - TOTAL REQUIRED

**REINFORCEMENT CUT SHEET**

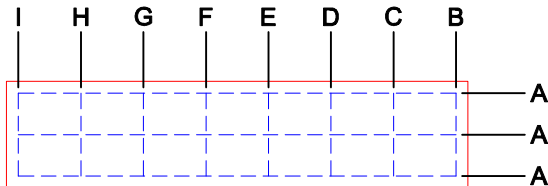

**TOP VIEW**

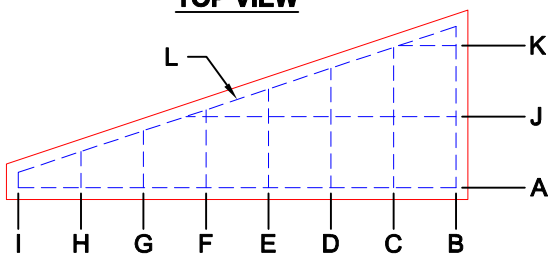

**FRONT VIEW**

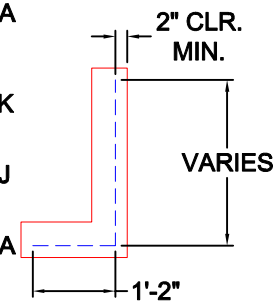

**END VIEW**

**GENERAL NOTES:**

1. MANUFACTURED TO ASTM C-913 (LATEST REVISION).
2. CONCRETE: 4,000 PSI AT 28 DAYS.
3. REINFORCING: #5 BAR @ 12" C-C E.W. SEE REINFORCEMENT CUT SHEET FOR ADDITIONAL INFORMATION. PER ASTM A615 (GRADE 60).
4. 1/2" CHAMFER ON ALL EXPOSED EDGES.
5. WEIGHT:  
 FIRST POUR - 707 LBS  
 SECOND POUR - 511 LBS  
 TOTAL - 1,218 LBS EACH
6. 48 TOTAL REQUIRED